

**Original HUCK
Bird's Nest®**
Art.no. 4650

- Available in two sizes: Ø 1.20 m (Art. 4650) Ø 0.90 m (Art. 4650-85)
- Ring wound round with rope and extra strong padding
- Entrapment-protected mat made of plastic links with steel-rope and chain attachment
- incl. chain suspension with reinforced-fabric "Original HUCK Bird's Nest®" protective sleeve or Hercules rope (Ø 16 mm, 6-strand, with steel core)
- With extra strong anti abrasion protection on the connections of the suspension chains to the nest and on the suspension-chain cross points!
- Only originals carry the green HUCK seal (stamped with serial number and manufacturing date)

**Quality.
Safety.
Fun.**

Exceeds all safety requirements of EN 1176-2:
extra strong padding, entrapment-protected linked mat



HUCK
Seiltechnik

HUCK Seiltechnik GmbH
Dillerberg 3
D-35614 Ablar-Berghausen

seiltechnik@huck.net
www.huck.net | www.seilwelten.de

Zentrale: +49 6443 8311-0
Telefax: +49 6443 8311-79
+49 6443 8311-53

Management
Wolfgang Keiner +49 6443 8311-68

Sales Department
Ria Gaidartzi +49 6443 8311-63
Roman Gerth +49 6443 8311-61
Sven Käbisch +49 6443 8311-71
Jasmin Küster +49 6443 8311-55
Michael Roth +49 6443 8311-81
Ellen Wendel +49 6443 8311-64

ria.gaidartzi@huck.net
roman.gerth@huck.net
sven.kaebisch@huck.net
jasmin.kuester@huck.net
michael.roth@huck.net
ellen.wendel@huck.net

**ACTION!
SPIDER!**



I BELIEVE I AM A SPIDER!

Climbing in 3D – this is what the new pyramid series by HUCK is all about. The spider pyramids are available in 4, 6 and 8m heights and with different guy lines. They are characterised by the spider web design and are designed with aluminium connectors.

www.werdelweit.info

HUCK

2014/2015

Catalogue No. 23

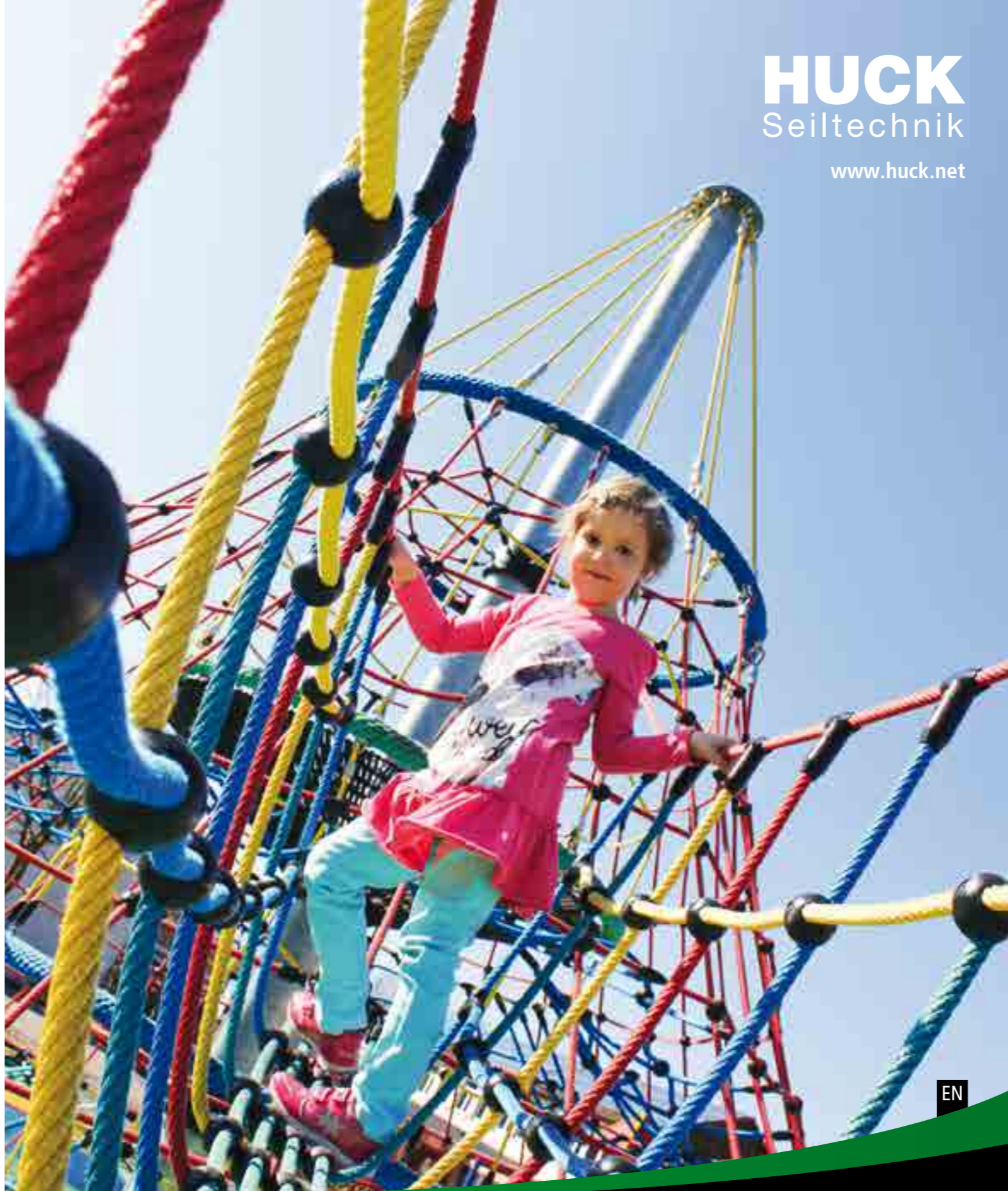

HUCK
Seiltechnik
www.huck.net

EN

Rope play equipment No. 23
2014/2015

HUCK – The competent partner for your ideas



12

**Only trust
the original**

The original HUCK Bird's Nest®

The original HUCK Bird's Nest® is a benchmark when it comes to quality and safety. Time and time again, we can see its features reflected in other copies. But our original is still the best. Because the ring wound round with rope has an extra strong padding.

The mat's high-quality plastic links protect from entrapment. The chain and rope suspensions are designed to carry maximum weight. Because we want to make absolutely sure that kids can have fun and be safe.

**Hally Gally
trampolines**

Round and rectangular – small and large

Hally Gally trampolines have been the name for dynamic fun in playgrounds for decades. Inserted in the ground or free-standing – these trampolines provide a lot of room for play, quality and safety.

From mini-sized to multi-user trampoline and solutions for wheelchair users – there is something for everyone. Our new development in this growing segment is even easier to maintain.



142



111

**New SPIDER
pyramid series**

The ultimate climbing fun in 3D

The new pyramid series by HUCK provides children with 3D climbing. The spider pyramids are available in 4, 6 and 8m heights and with different guy lines and can be designed with black climbing

ropes and orange-coloured aluminium connectors in the spider web look. Other colour combinations available upon request too.

■ Rope play equipment for the little ones	
Mini "Fortuna" pirate tower	15
Mini birds nest tree	17
"Fortuna" birds nest tree	18
Sparrow nest with slide	19
Gnome tree	20
"Junior" play ship	21
"Rabenscheid" Witches coven	22
"Berghausen" witches coven	23
Mini M swing	24
Toddler partner swinger	25
"Wobble disc" adventure bridge	26
"Crawl tunnel" adventure bridge	27

■ Rope play equipment for children aged 3 and above

Eagles nest carousel and springer	29
Birds nest springer	30
Nest carousel	31
Adventure and swinging honeycomb nest	32
Mini rope end swinger	33
Easy-climb 1	34
Easy-climb 4	35
Witches coven series	36
"Steindorf" spiders web	39
Heaxagonal mini climbing castle	40
Climbing star	41
Mini pirate tower	42
"Fortuna" course	43
Birds nest tower combi arch bridge	44
"Wobble beam" adventure bridge	45
"Wooden beam" adventure bridge	46
"Climbing wall" adventure bridge	47
Slackmaster series	48

■ Rope play equipment for children over the age of 4

Zeltnetz „Rabenscheid"	52
Sky-Castle	53
Piratenburg	54
Kletterdschungel „Erda"	55
6-Eck-Kletterburg Maxi	56
Kletter-Wigwam Midi	57
Netzturm „Sixt von Armin"	58
Mini Sanduhr	59
Netzwippen	60
Slackbar	62
Seiltänzer	63
Laternen-Nester	64

■ Rope play equipment for children aged 6 and above

"Lilse Bergen" play centre	66
Midi play ship	67
Play ship	69
Birds nest tree	71
Midi birds nest tree	73
Eagles nest tree	75
Birds nest tower	71
"Black Forest" birds nest tower	79
"Black Beard" pirate tower	80
"Black Beard" pirate ship	81
Maxi climbing wigwam	82

"Attighof" hourglass	83
Spinning mushroom	84
■ Rope play courses	
Course with robinia posts	86
Sports day assault course	88
Fun course 2010	92
Vario system	96
"Dillenburg" adventure course	100
Team-building course	102
■ Eagles nest series	
"Lotteschule" eagles nest	104
"Buehl" eagles nest	105
"Ehringshausen" eagles nest	106
"Asslar" eagles nest	107

■ Rope net pyramids

SPIDER pyramid series	111
Cheops pyramid series	119
Triops pyramid series	128
Rope net tower series	130
Dino series	133
Super climb series	138

■ Hally Gally series

Trampolines	142
Pendulum seat combination	151
Liana Swing	152
Space capsule	153
Climbing carousel	154
Beehive carousel	155
Ellipsislon	156
Climbing pyramid	157
Tower carousel	158
Climbing whirl	160
Birds nest carousel	162
Spiral carousel	163
Spinning toadstool	164
Witches carousel	164

■ Original HUCK birds nest + swings

Douglas fir swing frame	166
Douglas fir swing frame, long	166
Arch swing	168
"Junior" swing frame	169
Steel pipe swing frame, long	170
Mini M swing	171
Easy swing series	172
Original HUCK birds nest	175
Original HUCK mini birds nest	176
Original HUCK honeycomb nest	176
Universal joint, incl. safety bearings	176
Repair sets	177
Partner swings	178
Single swings	183
Swing hooks and joints	188

■ Group swings, hammocks + aerial runways	
"Rabenscheid" super rope-end swing	193
Maxi, midi, mini super rope-end swing	195
4-seater, mini super rope-end swing	198
Hammocks	200
Aerial runways	203

■ Obstacle-free rope-play equipment

"Midi" Easy-Swing	205
Maxi, midi, mini swing for those of limited mobility	206
"Easy-Swing" swing bed	207
Swing bed	208
Hammocks	209
Spinning honeycomb nest	211
Eagles nest carousel and springer	212
Original HUCK birds nest springer	212
"Rolli" trampoline for wheelchair users	213

■ Leisure, play & sport

Ball safety fences and nets	215
Football area goal nets	220
Volleyball nets	225
Basketball nets	226
Sun sail and cover sheets	227

■ Climbing nets, rope-ladders + ropes

Climbing nets	232
Connectors	235
Fastening options	236
Gymnast rings and clambering loops	242
Ropes and ladders	244
155	
156	
157	
158	
160	
162	
163	
164	

■ Net bridges + net tunnel System modules

Net bridges	252
Net tunnel	255
Frames	257
252	
255	
257	
260	
262	
270	

■ Net bridges + net tunnel Individual

Walkways + boardwalks	260
Airy nature trails	262
Individual play landscapes	270
176	
176	
177	
178	
183	
188	

■ Technical information

TÜV, subsurface and height of fall	275
Hercules quality	276
HUCK post solutions	277
Slides	279
List of Keywords and T&Cs.	281



HUCK – The competent partner for your ideas

An adventure play area is a magnet for children and perfect for running riot. And it stimulates fantasy. Whether the captain of a pirate ship, an explorer or princess in a castle – HUCK rope play equipment entuses children. As a specialist in the field of rope technology and competent contact partner for individual solutions for 20 years we have been producing rope play and climbing equipment as well as equipment for indoor and outdoor specialists.

Our products are based on more than the Huck Group's 50 years of experience in the net and rope technology sector and they guarantee durability and play enjoyment. With our diversified rope play equipment we design the most varied adventure landscapes. Climbing pyramids, group swings and Original HUCK birds nest swings can be found there as well as jungle bridges and climbing nets in all shapes and sizes.

Play worlds can be customised with rope-ladders, ropes, tyres and many other accessory parts. All products are based on the tried and tested HUCK quality, are easy to assemble and meet European safety regulations and TÜV (German test control body) standards. Our rope play equipment has been found in pre-schools, kindergartens, parks and on public play areas for many years now.

Individual experience play areas can be created from our multitude of climbing elements. In addition to the extensive product range with our standard equipment we also realise customer-tailored play worlds. Whether an airy nature trail in recreational parks, individual indoor play facilities or net tunnel landscapes at the zoo or outdoor swimming pool – we think with you and offer you a made-to-measure service.

Customers from all over the world trust us, HUCK has made a name for itself through its know-how and competent service. Whether in Europe, North America or the Middle East: we offer "Made in Germany" Huck quality. Numerous experienced sales partners focus on the customer by providing professional advice and being at your disposal as your point of contact. HUCK rope play equipment is also associated to a number of playground equipment manufacturers, with whom HUCK has had a successful cooperation for many years now.

We wish you great pleasure in discovering our new and our tried and tested HUCK products. Should you have any questions or require further information please do not hesitate to contact us!

HUCK – bringing your ideas to life!

General terms and conditions

Terms and conditions of sale and delivery

The following conditions form a significant part of the sales contract. They shall be deemed to be accepted by the buyer upon placement of a purchase order. Any other conditions of the buyer shall not apply even if they were not rejected in any individual case.

Offer

All offers made on the basis of this list are without engagement, non-binding and shall not obligate us to accept an order. Offers made by telephone need to be confirmed in writing. In case of doubt, the written confirmation shall be valid.

We reserve the right to make technical alterations that serve the further development of our products and that are acceptable to the buyer.

Purchase unit

We have the right to change differing order quantities to the next higher packing unit without enquiry. The exchange or return of custom-made products shall be precluded insofar as these are not defective.

Prices, packing

All prices are net and exclusive of the current statutory VAT. With the publication of this catalogue, all previous price lists shall be null and void! Our prices are non-binding to the extent that significant changes in raw-material prices and wages may occur after the publication of this catalogue and therefore the calculation bases may no longer apply. Should there be more than four months between the conclusion of the contract and the agreed delivery

date, and unless otherwise agreed at the conclusion of the contract, our prices at the time of delivery or preparation shall apply. We reserve the right to pass on the additional costs of raw materials in case of price increases in that area (steel, plastic, etc.) after completion of our catalogue. As a result, article prices may in some cases change correspondingly. Prices shall be valid for at least 1 year after the release of a catalogue, or until a new price list is published. Our prices are quoted „ex works", inclusive of packaging.

Liability/complaints

Our liability shall extend to sound handmade production, use of adequate materials and stable and durable construction. You shall notify us immediately of any deficiencies discovered, at the latest within three days of receipt of the goods or of discovery of the deficiency, should this only appear later, inasmuch as the buyer is a trader. Otherwise the goods shall be presumed to be approved. To the extent that no consumer sale has been made, we shall repair or replace free of cost at your option. Should a consumer sale have taken place, the buyer shall be able, in case of a justified complaint, to demand a repair or replacement at his option. Entitlement to a cancellation or reduction and/or to compensation shall only be given if according to our decision repairs cannot be carried out, are not possible or are unreasonable or a replacement cannot be made or the deadline for the same is not observed or an adequate extension given to us is not observed through our own fault. Should the repair or replacement finally fail, the buyer shall be able to demand a reduction in the fee or at his option the cancellation of the contract and/or compensation.

Warranty

The statutory conditions apply.

Guarantee

For Douglas fir posts where post shoes are used, we shall assume a guarantee of 10 years. For hot-dip galvanised steel posts, 15 years against rust penetration. Three years' guarantee for wooden posts in case of direct installation! For all other pieces (with the exception of wear and tear parts), we shall give a guarantee of 5 years against breakage and material defects. Our guarantee shall be assumed to the extent described under the liability clause. The guarantee shall not extend to parts that are subject to rapid wear (wear and tear parts). The buyer's statutory warranty rights are not affected by this. Damage attributable to wilful destruction (vandalism), incorrect installation, inadequate maintenance or natural wear and tear shall be exempt from the guarantee. Our installation and maintenance instructions must be followed.

Delivery arrangements:

Delivery times specified by the buyer and their receipt do not constitute a promise of delivery. No compensation claim can be derived from a breach of delivery times. Force majeure and strikes either on our premises or on those of our preliminary suppliers shall release us from delivery obligations. If delivery is not possible, in the presence of the conditions described above, the term of delivery shall be extended.

Naturally grown woods

Robinia – natural, robust, versatile

HUCK play equipment with robinia posts has a natural appearance and is optically first-class. The wood grows twisted and buckled, giving the play systems a primordial and natural feel.

Robinia is splinter-free and has a long life without needing any chemical treatment. Its natural appeal knows no bounds when it is combined with numerous rope components.



86



The perfect rope connection

HUCK rope connections at a glance

Whether knot balls, knot-tied or stainless steel clips: HUCK rope connections are characterised by a clear design and are pleasant to the touch. Depending on the rope colour the knot balls for example can be created in beige or black. The knot-tied design, which is embedded perfectly

into the rope, are especially suitable for hammocks, whilst the HUCK stainless steel clip is characterised by its durable material above all and a high-quality design which suits every type of rope and colour.

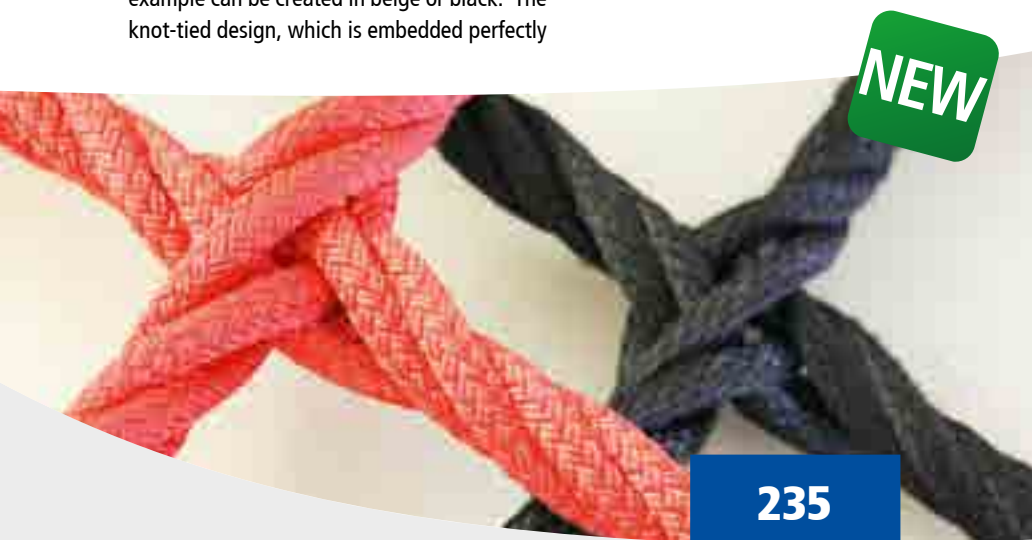

235

Project planning

for customised playworlds

Are you looking for an individual solution for your project?

We offer a made-to-order service!

The section "net bridges and net tunnels" gives examples of individual solutions which we have developed based entirely on the wishes of our customers.



259

HUCK International

Germany

HUCK Seiltechnik GmbH
Dillerberg 3
D-35614 Aßlar-Berghausen
Phone: +49 6443 8311-0
Fax: +49 6443 8311-79
seiltechnik@huck.net

Netherlands

HUCK Torimex BV
Kalkbranderstraat 5
2222BH Katwijk aan Zee
Phone: +31 71 409 77-00
Fax: +31 71 409 77-01
sales@huck-torimex.com

Sweden

ScanCord AB
Svetsaregatan 11
242 22 Hörby
Phone: +46 415 15 400
Fax: +46 415 15 425
info@scancord.net

USA

International Cordage East
226 Upton Road
US 06415 Colchester
Phone: +1 800 596 1066
Fax: +1 860 537 7393
info@hucknet.com

Belgien

HUCK N.V.
Atlasstraat 2
B-8680 Koekelare
Phone: +32 51 58 23 20
Fax: +32 51 58 20 55
info.sales@huck.be

Austria

Berger GmbH
Industriestrasse 9
A-2000 Stockerau
Phone: +43 22 66 62 126
Fax: +43 22 66 62 126-27
sales.at@huck.at

Czech Republic

Berger-HUCK s.r.o.
Vanišova 552
533 74 Horní Jelení
Phone: +420 466 673-306
Fax: +420 466 673-305
info@berger-huck.cz

France

HUCK Occitania S.A.
Les Clauzolles
F-81470 Maurens Scopont
Phone: +33 563 82 51-31
Fax: +33 563 82 51-36
contact@huck-occitania.fr

Poland

HUCK Polska Sp. z o.o.
Ul. Obornicka 78
51-114 Wrocław
Phone: +48 71 326 08 95
Fax: +48 71 325 34 22
biuro@huck.pl

United Kingdom

HUCK Nets Ltd.
Gore Cross Business Park,
Corbin Way, Bradpole Bridport
DT6 3 UX, Dorset
Phone: +44 1308 425 100
Fax: +44 1308 458 109
sales@hucknetting.co.uk

HUCK contacts

Telephone: 01308 425100
Fax 01308 458109

Managing Director

Richard Connolly
richard@hucknetting.co.uk

Sales Director

Jon Legg-Bagg
jon@hucknetting.co.uk

Play Manager and Designer

Tony Lucas
tony@hucknetting.co.uk

Sales and Administration

Sarah Reynolds
sarah.reynolds@hucknetting.co.uk

Logistics Manager

Dave Symonds
dave.symonds@hucknetting.co.uk

HUCK Social Media



facebook.com/huck.seiltechnik – Besuchen Sie uns auf unserer facebook-Seite und werden Sie Fan!

HUCK Group



Rope play equipment

Pure fun with the rope play equipment of HUCK Seiltechnik. Interesting for public areas: our hanging bridges in various styles and the freely expandable equipment combinations.



Industrial nets

A world of nets for technology and the environment: lift, tie down, load, cover, protect, secure. A world of nets belongs in a world of technology.



Safety nets

Safety nets are used as safety nets for persons or as lateral safety nets. HUCK safety nets are EN (European standard). You can also rent our scaffolding safety nets.



Sport nets and ropes

Here you can find nets for football, handball, volleyball, badminton, tennis, beach & fun games and many other ball sports.



www.huck.net

Planning and ordering online.

Simplify your planning: with brief descriptions, photos and sketches on the newly overhauled website, **www.huck.net**, choosing your new play equipment for your project has never been easier! As-

sembly instructions are there to help you during planning. Safety and quality can be reaffirmed in the Download-Center – TÜV certificates are testimony of our standards.



www.seilwelten.de

Go online and find information

The newly created website **www.seilwelten.de** gives an overview of all HUCK rope play equipment. As an online catalogue there is also the different issues of our main catalogues and the Seilwel-

ten magazine. We hope you enjoy browsing through our catalogue. There you will also find product news from the last year as well as all news about the HUCK company at a glance.

HUCK Newsletter

Always on the cutting edge

With the HUCK newsletter you will receive interesting information about new rope play equipment, the latest designs and completed

projects. This way you are always up to date and regularly receive new ideas for future projects.



Notes



New products for 2014

For an overview of our new features, please see pages 9-11.



This symbol depicts our climbing products suitable for children aged 2 and over.

When developing our play equipment we make sure that the fall height of the equipment does not exceed 1.00 m, wherever possible.



Not every piece of play equipment has the same play advantages for children of different ages. We therefore state the recommended minimum age for every piece of rope play equipment.



Obstacle-free play equipment is indicated by this symbol. Our range of swings is particularly varied, where even people with limited mobility can find what they're looking for.



Dig-in ground anchors are a sophisticated option for a reasonably-priced and simple installation. Installed with ground anchors, equipment is set up and ready very quickly - no tiresome waiting time until the concrete is set.



You can choose different colour combinations or a single-colour design for these items. Please see page 233 for your choice of available rope colours.



All play equipment is available in different colour combinations or solid colours upon request. The selection of rope colours available can be found on Page 233.

Technical data	
Equipment height:	2.50 m
Space requirement:	2.35 x 3.40 m
Safety zone:	5.35 x 6.40 m
Min. fall protection:	25.50 m ²
Height of fall:	1.50 m
Ground surface:	see table on page 275

Definition of terms in the table "Technical Data"

Space requirement = maximum dimensions of the equipment, sometimes including the required foundation measurements (if these exceed the safety zone).

Safety zone = Space needed for the safe use of the equipment, including the falling range, open space and space requirement (without foundations, if applicable)..



Hot-dip galvanised steel posts

We can provide most of our steel posts with powder coating for an additional fee on request. However, we are convinced of the quality of our hot-dip galvanised steel posts as they have numerous advantages:

- ⊕ scratch-resistant surface (shiny silver)
- ⊕ significantly lower price
- ⊕ robust during transport, storage and assembly
- ⊕ can be easily and quickly painted on site with high-quality paint that is included in the scope of delivery
- ⊕ quickly repainted when surfaces become damaged
- ⊕ damage to powder-coated posts attacks the surface structure and is difficult to repair
- ⊕ silver suits many net colours

NEW**New products
for 2014**

27

**"Crawl tunnel"
Adventure bridge**

Art.no. 4959-80

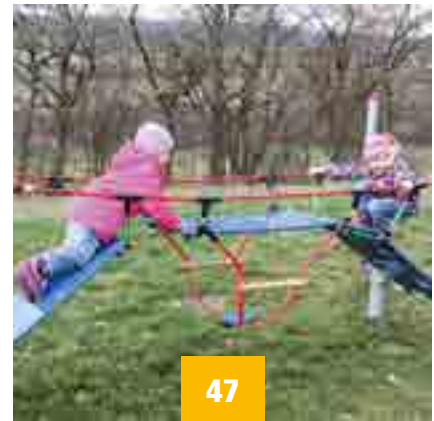

47

**"Climbing wall"
Adventure bridge**

Art.no. 4959-81

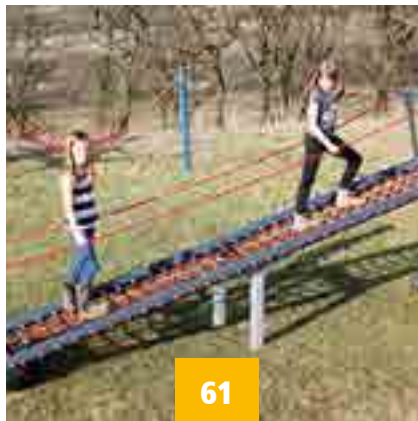

61

**Net seesaw
made from steel**

Art.no. 45875

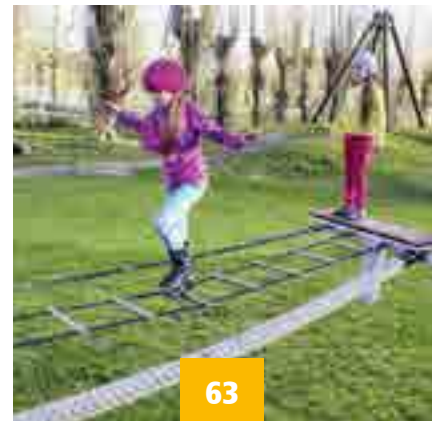

63

Tightrope

Art.no. 4591-73



67

Midi play ship

Art.no. 4631-215

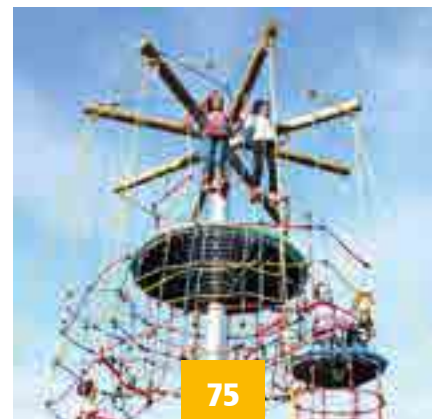

75

Eagles nest tree

Art.no. 4652-40

NEW

New products for 2014



79

"Black forest" Birds nest tower

Art.no. 4652-21



81

"Black Beard" pirate ship

Art.no. 4687-25

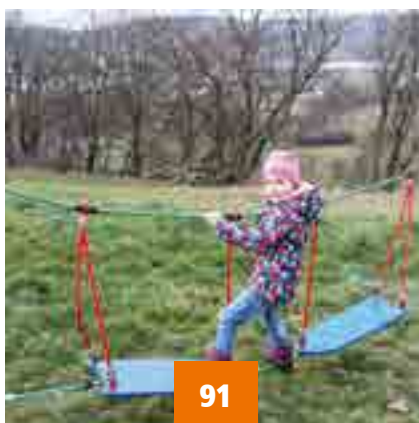

91

Surfer

Art. no. 4591-15 for steel posts

Art. no. 4591-15-R for robinia posts with chain and PA discs



105

"K2" eagles nest

Art. no. 4634-20



117

SPIDER 8

With 6 guy lines

Art.no. 5000-8-6



146

"Triangulum" trampoline

Art.no. 20.02.103



91

Goal and climbing wall

Art. no. 4591-18 for steel posts

Art. no. 4591-18-R for robinia posts, with chain and PA plates/discs



91

Labyrinth Ball

Art. no. 4591-16 for steel posts

Art. no. 4591-16-R for robinia posts, with chain and PA plates/discs

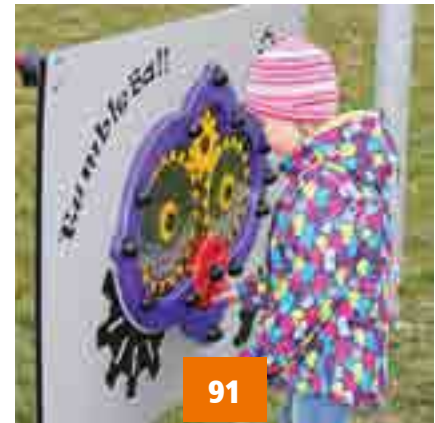

91

1000 balls

Art. no. 4591-17 for steel posts

Art. no. 4591-17-R for robinia posts, with chain and PA plates/discs



111

SPIDER 4

with 4 guy lines

Art. no. 5000-4-4



113

SPIDER 6

with 4 guy lines

Art. no. 5000-6-4



115

SPIDER 6

with 6 guy lines

Art. no. 5000-6-6



150

Trampoline 2014

Art. no. 20.02.102



159

Mini tower carousel

Art. no. 20.01.151



224

"Goalie sport" Football area goal

Art. no. 4665



* For durable, long-lasting swinging experience:
All HUCK nest swings now come with completely reworked and extra strong anti abrasion protection on the connections of the suspension chains to the nest and on the suspension-chain cross points!

Original HUCK Bird's Nest®

Art. no. 4650

Equipment

Two-point suspension

Colourful rope ring (Ø 1.20 m), padded, standard colour blue or green (also available in red, black or hemp on request)

Seat made of steel-rope chain-link mat

Suspension chains with rubber-fabric tubing (red), with Hercules rope on request

Delivered without suspension bearings (we recommend universal joint, art. no. 4608-1)

Suspension height 2.00 m or 2.50 m or as universal suspension up to a suspension height of 2.00 m to 2.50 m (please specify at time of order)

Technical data

Suspension height:	2.00 m	2.50 m
Diameter:	ca. 1.20 m	ca. 1.20 m
Bore spacing:	1.90 m	1.90 m
Min. distance to swing frame:	0.70 m	0.70 m
Height of fall:	2.10 m	2.35 m
Ground surface:	see table on page 275	see table on page 275



Exceeds all safety requirements of EN 1176-2: extra strong padding, entrapment-protected linked mat

Only trust the original!

Safety comes first with HUCK play equipment. This is why the HUCK Bird's Nest® is extremely popular and extra safe.

In the HUCK Bird's Nest®, the children play on a close-knit mesh mat that does not allow any arms and legs to slip through. The risk of injury is therefore extremely small.

Of course the standard for play equipment also has specific requirements for the padding and the HUCK Bird's Nest® clearly exceeds these.

Another quality criterion:

The extra-strong abrasion protection for super stressed connecting pieces, such as the chains hanging the baskets.

A very weather-resistant rubber hose sleeve (flexible in the cold) for the HUCK hanging chains offers optimal protection for intense use. Our bird's nest is very popular!

Maintenance is very easy:

The play equipment can be repaired in its suspended state with no problems at all.

All materials used come with a 5-year warranty. With the proper care and maintenance, the children can enjoy the play equipment for a long time.

Made in Germany quality!

The standard HUCK Bird's Nest® has a blue wrapped rope. Here you can see other colours such as green, black, red and natural hemp. Our experience and standards guarantee quality of the highest level – HUCK quality "made in Germany"!

Conclusion:

Only trust the original!
Because only the HUCK Bird's Nest® combines fun, durability and safety.



Blue wrapped rope,
red protective chain sleeve



Green wrapped rope,
red protective chain sleeve

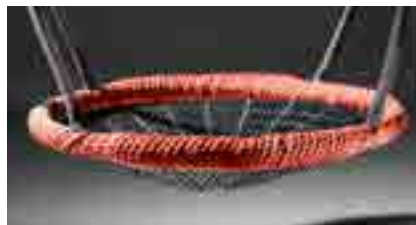

Red wrapped rope,
black protective chain sleeve (special model)



Hemp wrapped rope,
black protective chain sleeve (special model)



Black wrapped rope,
black protective chain sleeve (special model)

Use the advantages of all original HUCK nest swings!

Safety and high play value

- ⊕ Narrow-mesh chain-link mats
- ⊕ Protection against arms and legs slipping or being pushed through
- ⊕ Nest-shaped base
- ⊕ Extra-strong padding

Premium quality

- ⊕ Additional chafing protection on connecting parts
- ⊕ Suspension chains enclosed in very high-quality, weatherproof rubber-fabric tubing that remains flexible at low temperatures
- ⊕ 5-year guarantee on all materials

Very easy to maintain

- ⊕ Repairs to nest mats carried out on site where they hang
- ⊕ High availability of replacement parts
- ⊕ HUCK service with pickup and redeliver

The name "Bird's Nest" ® is a long-standing registered trade name of HUCK Seiltechnik GmbH.



Rope play equipment for the little ones



HUCK play and climbing equipment has been specially designed for playgrounds for children over the age of 2. Various adventure bridges, carousels, and assault courses enable the toddlers to play freely and discover a miniature magical world. Diverse climbing options allow the little ones to let off steam. HUCK provides, for instance, practical buried ground anchors and assembly solutions for flat roofs so that erecting the equipment becomes child's play. During the development of the mini play equipment, great emphasis was placed on toddler safety – according to the corresponding recommendations for the various age groups – and the TÜV certified this by awarding us its quality seal for Europe-wide safety standards.

| 15 |



Toddler pirate tower

| 17 |

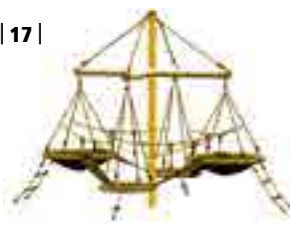

Mini bird's nest tree

| 18 |



Bird's nest tree house

| 19 |



Sparrow's nest with slide

| 20 |



Gnome tree

| 21 |



"Junior" play ship

| 22 |



Witch's slide & net

| 23 |



Witch's look-out

| 24 |



Mini-M-swing

| 25 |

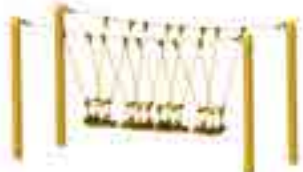

Toddler duo swinger

| 26 |



"Wobble disk" adventure bridge

| 27 |

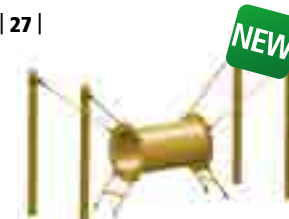

"Crawl tunnel" adventure bridge



Mini pirate tower "Fortuna"

Art.no. 4687-35

Equipment

- 1 steel post (Ø 102 mm), hot-dip galvanised, length 3.40 m, with cap
- 4 crossbeams with caps
- 1 original HUCK Bird's Nest® (Ø 1.20 m)
- 2 climbing ladders, short
- 2 climbing ladders, long
- Ropes and nets made of Hercules rope (Ø 16 mm, 6-strand, with steel core)

Technical data

Equipment height:	2.50 m
Space requirement:	2.35 x 3.40 m
Safety zone:	5.35 x 6.40 m
Min. fall protection:	25.50 m ²
Height of fall:	1.50 m
Ground surface:	see table on page 275



Mini pirate tower
(page 42)
Pirate tower
(page 80)

Also available with
slide upon request!
(page 279)

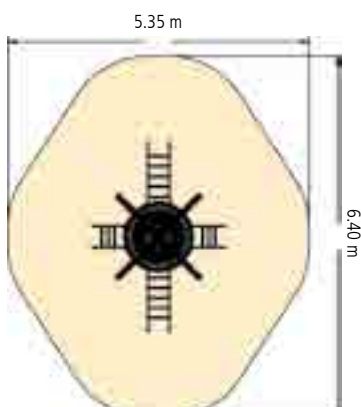

HUCK

2014/2015





Mini bird's nest tree

Art.no. 4652-30

Equipment

- 1 steel post (Ø 102 mm), hot-dip galvanised, length 3.40 m, with cap
- 4 steel crossbeams (Ø102 mm), hot-dip galvanised, with cap
- 2 original HUCK honeycomb nests (Ø 1,00 m)
- 2 steel rings wound round with rope (Ø 660 mm), galvanised, with base
- Connections with rubber belts
- 2 climbing ropes
- 2 climbing ladders
- Various suspension ropes
- Ropes and nets made of Hercules rope (Ø 16 mm, 6-strand, with steel core)

Technical data

Equipment height:	2.50 m
Space requirement:	3.70 x 3.20 m
Safety zone:	6.10 x 5.75 m
Min. fall protection:	25.00 m ²
Height of fall:	0.70 m
Ground surface:	see table on page 275



Bird's nest tree
(page 71)
Midi bird's nest tree
(page 73)

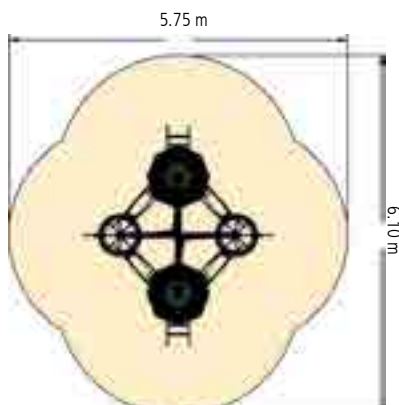



Bird's nest tree house

Art.no. 4594-30

 Bird's nest tower (page 77)

Equipment

1 steel posts (Ø 102 mm), hot-dip galvanised, length 3.00 m, with caps, special paint (red) included in delivery

1 original HUCK Bird's Nest® (Ø 1.20 m)

Rope ladder with PA rungs

Ropes and nets made of Hercules rope (Ø 16 mm, 6-strand, with steel core)

Technical data

Equipment height: 2.00 m

Space requirement: Ø 2.70 m

Safety zone: Ø 5.70 m

Min. fall protection: 26.00 m²

Height of fall: 1.00 m

Ground surface: see table on page 275

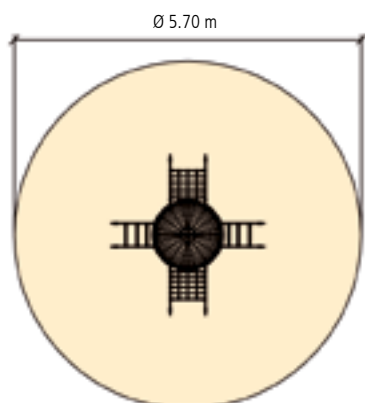



Sparrow's nest with slide

Art.no. 4668-31

Equipment

- 1 steel post (Ø 140 mm), hot-dip galvanised, special paint (red) included in delivery
- 1 HUCK honeycomb nest (Ø 1.00 m)
- 2 climbing ladders with plastic rungs
- 1 climbing rope
- 1 GRP slide (red), with grip bar
- Ropes and nets made of Hercules rope (Ø 16 mm, 6-strand, with steel core)

Technical data

Equipment height:	0.85 m (with 0.25 cm slide curve)
Space requirement:	1.60 x 2.35 m
Safety zone:	4.65 x 4.90 m
Min. fall protection:	18.00 m ²
Height of fall:	0.55 m
Ground surface:	see table on page 275

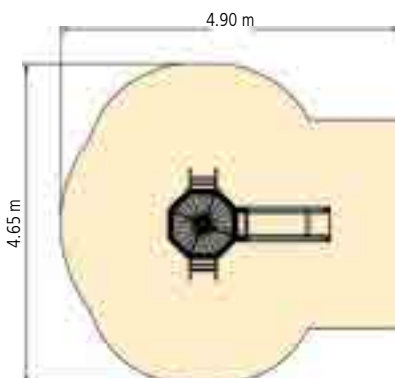



Gnome tree

Art.no. 4594-20

Equipment

1 steel posts (Ø 160 mm), hot-dip galvanised, length 3.00 m, with cap, special paint (red) included in delivery

Metal parts made of stainless steel or hot-dip galvanised

Rubber climber with climbing aids with buried ground anchor

Ropes and nets made of Hercules rope (Ø 16 mm, 6-strand, with steel core)

Technical data

Equipment height:	2.20 m
Space requirement:	3.75 x 2.55 m
Safety zone:	6.75 x 5.55 m
Min. fall protection:	30.00 m ²
Height of fall:	1.00 m
Ground surface:	see table on page 275

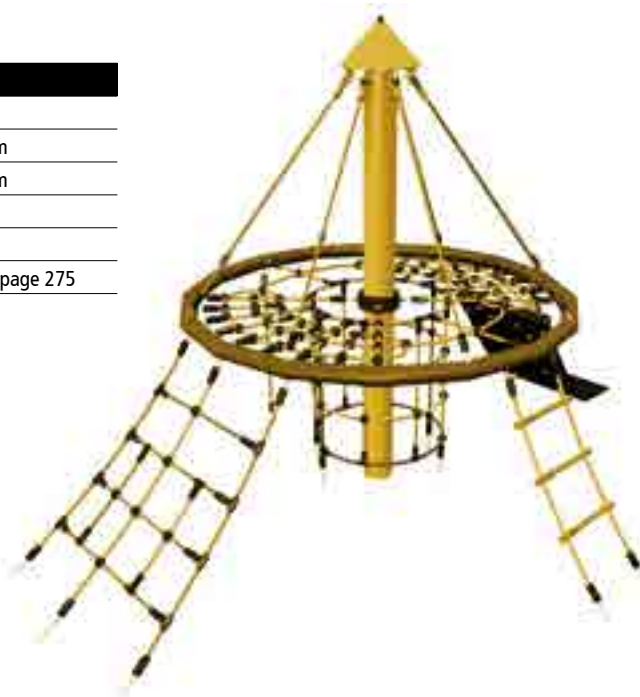
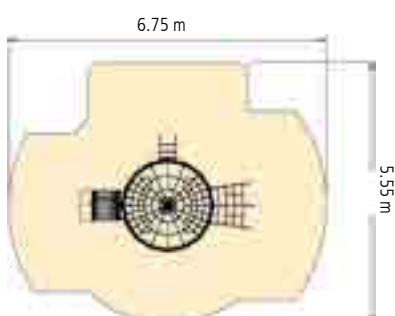

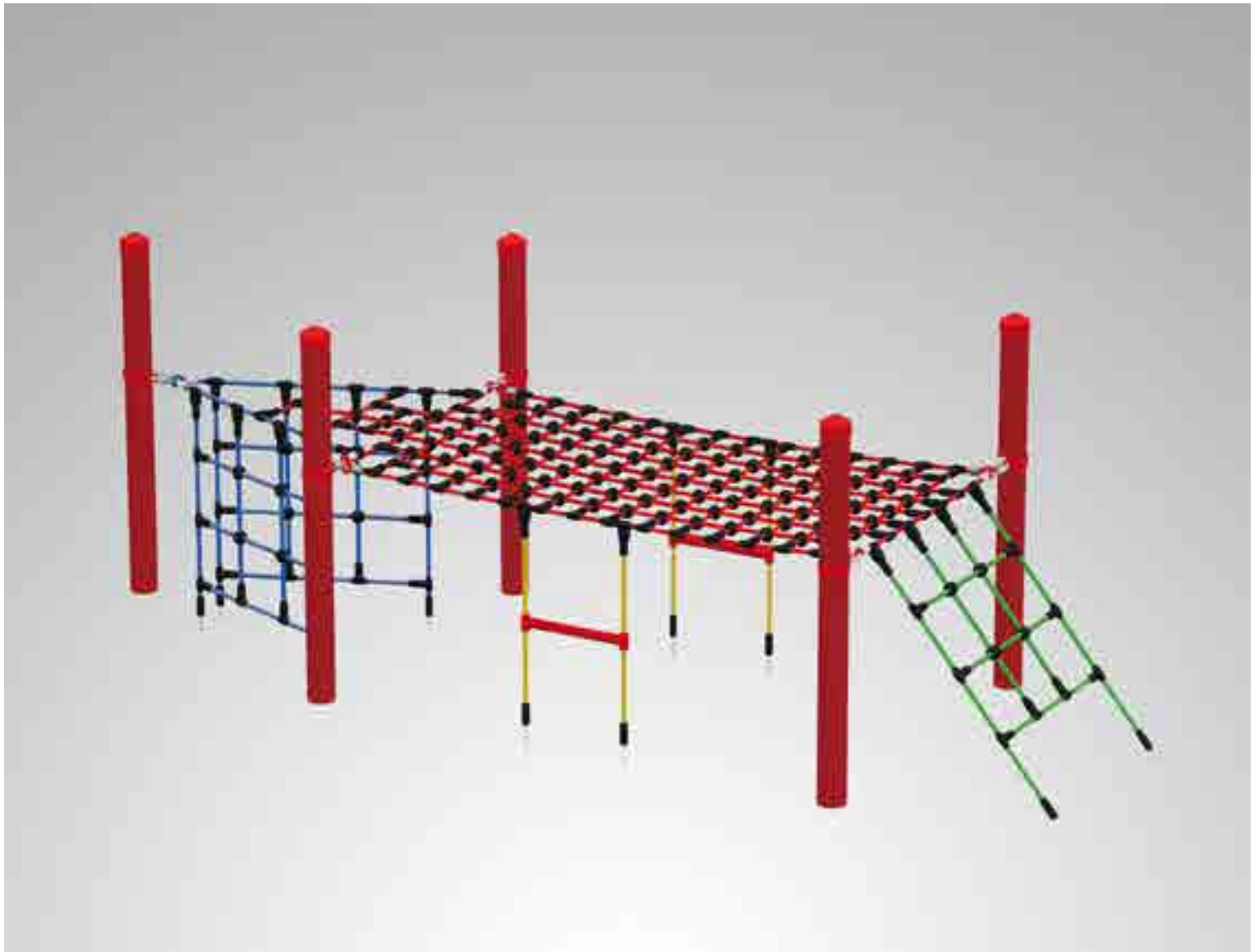

"Junior" play ship

Art.no. 4642-10

Equipment

5 steel posts (Ø 102 mm), hot-dip galvanised, length 2.00 m, with plastic cap, special paint (red) included in delivery

1 horizontal climbing net

1 horizontal triangle net

2 vertical climbing nets

1 angled climbing net

2 climbing ladders with plastic rungs

Ropes and nets made of Hercules rope (Ø 16 mm, 6-strand, with steel core)

Technical data

Equipment height: 1,30 m

Space requirement: 3.80 x 1.40 m

Safety zone: 6.65 x 4.00 m

Min. fall protection: 22.50 m²

Height of fall: 0.80 m

Ground surface: see table on page 275

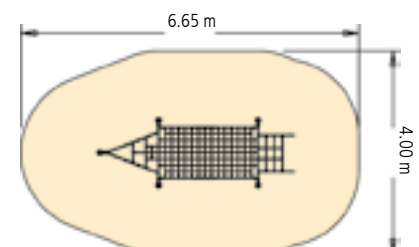



Witch's slide & net

Art.no. 4591-20

Equipment

4 steel posts (Ø 102 mm), hot-dip galvanised, length 2.00 m, special paint (red) included in delivery

1 GRP slide with bar

1 rope ladder

1 climbing net

1 ladder walk

1 horizontal net

Ropes and nets made of Hercules rope (Ø 16 mm, 6-strand, with steel core)

Technical data

Equipment height: 1.20 m
(up to slide bar: 1.70 m)

Space requirement: 5.60 x 1.70 m

Safety zone: 8.70 x 4.70 m

Min. fall protection: 30.00 m²

Height of fall: 1.00 m

Ground surface: see table on page 275

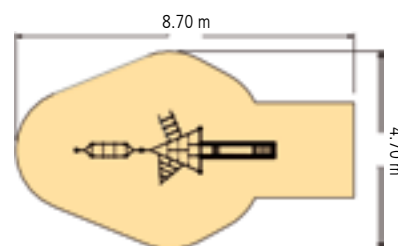

Also available in stainless steel on request! (page 279)



We reserve the right to make technical alterations.



Witch's look-out

Art.no. 4594-11

Equipment

5 steel posts (Ø102 mm), hot-dip galvanised, length 2.00 m, with cap, special paint (red) included in delivery

1 horizontal triangle net

1 angled climbing net

1 vertical climbing net

1 climbing ladder

1 Tyre swing with suspension ropes

Ropes made from Hercules rope (Ø 16 mm, 6-strand, with steel core)

Technical data

Equipment height: 1.30 m

Space requirement: 3.30 x 1.90 m

Safety zone: 6.30 x 4.90 m

Min. fall protection: 24.00 m²

Height of fall: 1.10 m

Ground surface: see table on page 275

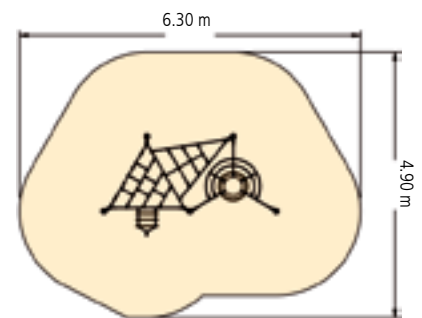



Mini M-swing

Art. no. 4540-10 Posts with suspension bearings, without hanging components

Art. no. 4540-10-04 Posts with suspension bearings, without hanging components, powder-coated

Equipment

2 steel posts (Ø 102 mm), hot-dip galvanised, length 2.40 m, with caps and suspension bearings, special paint (blue) included in delivery, powder-coated in Gentian Blue (RAL 5010) available for an additional charge

2 swing bearings (art. 4602M)

Technical data

Equipment height:	1.45 m
Space requirement:	2.30 x 0.90 m
Safety zone:	2.30 x 6.30 m
Min. fall protection:	14.50 m ²
Height of fall:	1.45 m
Ground surface:	see table on page 275

Caution!

The space required for the equipment foundation (assembly space) is larger than the safety zone.



4540-10 + 4650-85M

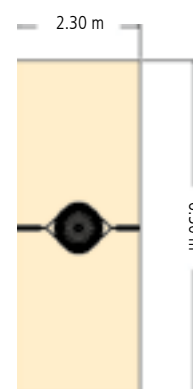

SUPER PRACTICAL!

With the dig-in anchors this play equipment is simple to set up and can be played on immediately (page 249)



Recommended hanging components:

Original HUCK Bird's Nest®

Art. no. 4650-85M (see page 176)



Toddler swing

Art. no. 4693M (see page 185)





Toddler quad swinger 4-seater

Art.no. 4693-40-3

Equipment

4 steel posts (Ø102 mm), hot-dip galvanised, length 2.00 m, with cap, special paint (blue) included in delivery

4 toddler swing seats (art. 4693), facing each other

incl. suspension ropes and tension ropes between posts

Ropes made from Hercules rope (Ø 16 mm, 6-strand, with steel core)

Technical data

Equipment height: 1.60 m

Space requirement: 3.10 x 1.10 m

Safety zone: 6.10 x 2.40 m

Min. fall protection: 14.65 m²

Height of fall: 1.00 m

Ground surface: see table on page 275

Also available as
2-seater!

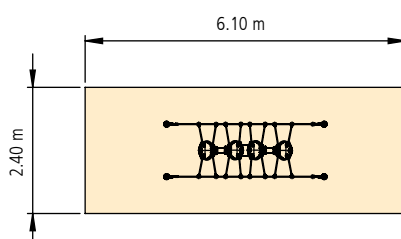



“Wobble disk” adventure bridge

Art.no. 4959-60

Equipment

4 steel posts (Ø 102 mm), hot-dip galvanised, length 2.00 m, with plastic cap and PE base, special paint (blue) included in delivery

1 net bridge with PE disks as walkway, length 3.00 m

Ropes and nets made of Hercules rope (Ø 16 mm, 6-strand, with steel core)

Technical data

Equipment height: 1.20 m

Space requirement: 3.10 x 1.10 m

Safety zone: 6.10 x 4.10 m

Min. fall protection: 23.00 m²

Height of fall: 0.65 m

Ground surface: see table on page 275

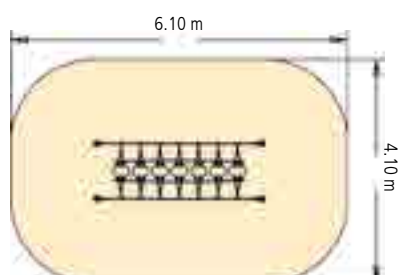



“Crawl tunnel” adventure bridge

Art.no. 4959-80

Equipment

4 steel posts (Ø 102 mm), hot-dip galvanised with plastic caps, special colour paint (Blue)
Supplied

1 creeping willow tube, Ø 600mm, GRP, red

2 entry ladders

4 suspension ropes

Hercules ropes and nets
(Ø 16mm, 6-strand, with steel core)

Technical data

Equipment height: 1.70 m

Space requirement: 3.10 x 1.10 m

Safety zone: 4.80 x 3.40 m

Min. fall protection: 14.00 m²

Height of fall: 0.50 m

Ground surface: see table on page 275

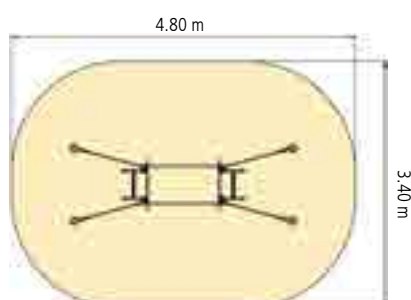

Rope play equipment for children over the age of 3



Children over the age of 3 start developing considerably faster. The HUCK rope play equipment for this age group allows children's imaginations to run wild and gives free rein to their natural urge to be active. It blends harmoniously into virtually any adventure landscape and can be tailored to very specific individual requirements. All play systems can be combined with various possible climbing elements such as climbing nets, net ramps, rope ladders or rubber flooring. The play systems also come with a wide range of different structural design elements in every shape and colour. Whether they have a slide, swing or climbing chimney – fun is guaranteed!

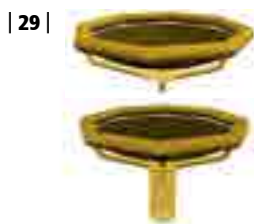

| 29 |
Honeycomb Carousel
Honeycomb Springer



| 30 |
Birds Nest Springer



| 31 |
Nest carousel

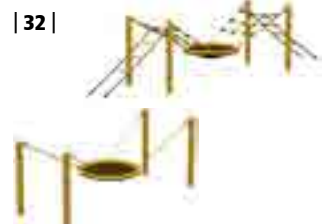

| 32 |
Adventure honeycomb nest
Swinging honeycomb nest

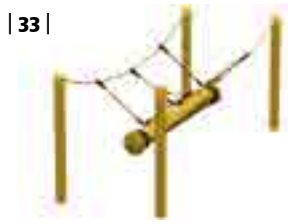

| 33 |
Mini rope-end swing

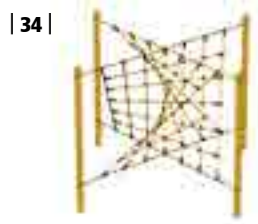

| 34 |
Easy-Climb 1

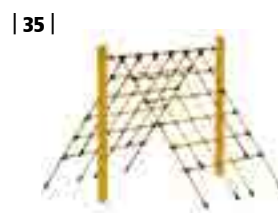

| 35 |
Easy-Climb 4



| 36 |
Witch's slide & net series

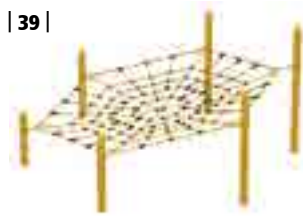

| 39 |
Spider web net



| 40 |
Mini hexagon climbing castle



| 41 |
Climbing star

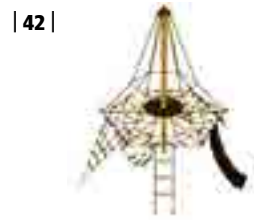

| 42 |
Mini pirate tower

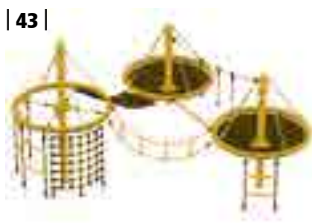

| 43 |
'Fortuna' play course



| 44 |
Tower bridge

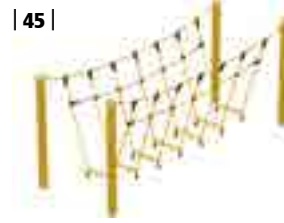

| 45 |
'Wobble rung' adventure bridge



| 46 |
'Wooden catwalk' adventure bridge



| 47 |
'Climbing wall' adventure bridge

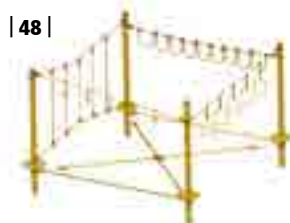

| 48 |
Slackmaster-series

NEW



Honeycomb Carousel

Art. no. 4668-20 with buried ground anchors

Equipment

1 HUCK honeycomb nest (Ø 1.00 m)

Bars galvanised, painted red

1 buried ground anchor, hot-dip galvanised, with pivot bearings

Technical data

Equipment height: 0.45 m

Space requirement: Ø 1.00 m

Safety zone: Ø 5.00 m

Min. fall protection: 19.50 m²

Height of fall: 0.45 m

Ground surface: see table on page 275



Ø 5.00 m

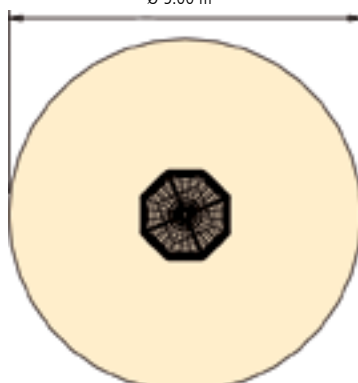

Honeycomb Springer

Art. no. 4668-10 with buried ground anchors

Equipment

1 HUCK honeycomb nest (Ø 1.00 m)

Bars galvanised, painted red

1 buried ground anchor, hot-dip galvanised, with 1 steel spring (powder-coated)

Technical data

Equipment height: 0.75 m

Space requirement: Ø 1.00 m

Safety zone: Ø 4.00 m

Min. fall protection: 12.50 m²

Height of fall: 0.90 m

Ground surface: see table on page 275



Ø 4.00 m

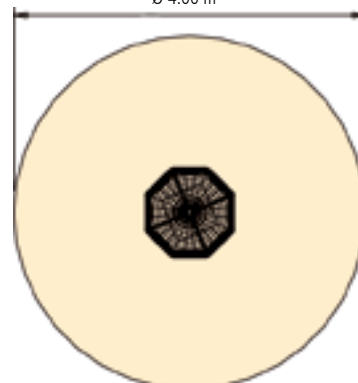



Birds Nest Springer

Art. n.o. 4670 with buried ground anchors

Equipment

- 1 original HUCK Bird's Nest® (Ø 1.20 m)
- Bars galvanised, painted red
- Glulam plate
- 1 buried ground anchor, hot-dip galvanised, with 3 springs

Technical data

- Equipment height: 0.85 m
- Space requirement: Ø 1.30 m
- Safety zone: Ø 4.30 m
- Min. fall protection: 15.00 m²
- Height of fall: 1.00 m
- Ground surface: see table on page 275

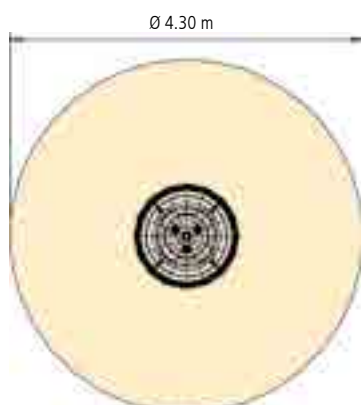

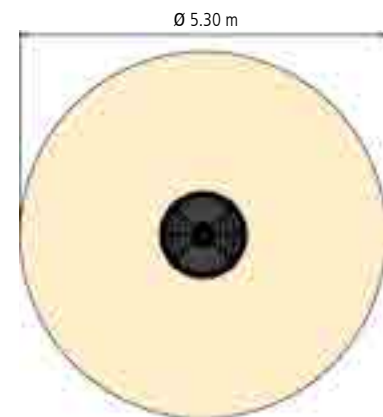

Nest carousel

Art.no. 4594-41

Equipment

1 steel posts (Ø 102 mm), hot-dip galvanised, length 3.00 m, special paint (red) included in delivery, with aluminum cap, red, powder-coated

1 original HUCK Bird's Nest[®] (Ø 1.20 m)

2 angled nets

Ropes and nets made of Hercules rope (Ø 16 mm, 6-strand, with steel core)

Technical data

Equipment height: 1.75 m

Space requirement: Ø 1.30 m

Safety zone: Ø 5.30 m

Min. fall protection: 22.00 m²

Height of fall: 1.00 m

Ground surface: see table on page 275



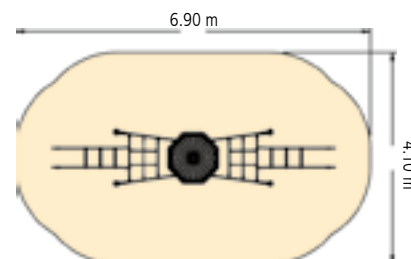

Adventure honeycomb nest

Art.no. 4959-70

Equipment

4 steel posts (Ø 102 mm), hot-dip galvanised, length 2.00 m, with plastic cap, special paint (blue) included in delivery

1 HUCK honeycomb nest (Ø 1.00 m)

2 climbing ladders with plastic rungs

2 crossing walkway nets

Ropes and nets made of Hercules rope (Ø 16 mm, 6-strand, with steel core)

Technical data

Equipment height: 1.30 m

Space requirement: 4.50 x 1.10 m

Safety zone: 6.90 x 4.10 m

Min. fall protection: 25.00 m²

Height of fall: 1.00 m

Ground surface: see table on page 275

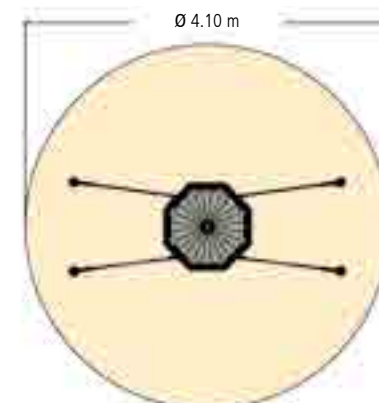

Swinging honeycomb nest

Art.no. 4959-71

Equipment

4 steel posts (Ø 102 mm), hot-dip galvanised, length 2.00 m, with plastic cap, special paint (blue) included in delivery

1 HUCK honeycomb nest (Ø 1.00 m)

4 suspension ropes

Ropes and nets made of Hercules rope (Ø 16 mm, 6-strand, with steel core)

Technical data

Equipment height: 1.30 m

Space requirement: 3.10 x 1.10 m

Safety zone: Ø 4.10 m

Min. fall protection: 13.20 m²

Height of fall: 0.55 m

Ground surface: see table on page 275





Mini rope-end swing

Art.no. 4585-45

Equipment

4 steel posts (Ø 102 mm), hot-dip galvanised, length 2.00 m, with caps, special paint (blue) included in delivery

Metal parts made of stainless steel or hot-dip galvanised

PP rope end (Ø 160 mm)

Hanging rope made from Hercules rope (Ø 16 mm, 6-strand, with steel core)

Technical data

Equipment height: 1.20 m

Space requirement: 3.10 x 1.10 m

Safety zone: 6.10 x 4.10 m

Min. fall protection: 23.00 m²

Height of fall: 0.80 m

Ground surface: see table on page 275

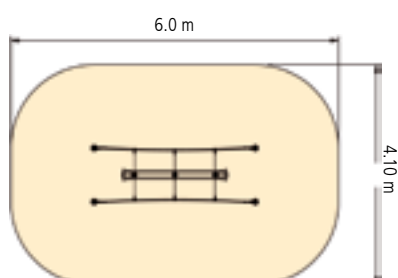



Easy-climb 1

Art.no. 4591-40-1

Equipment

4 steel posts (Ø 102 mm), hot-dip galvanised, length 3.00 m, with caps and fixing attachments, special paint (red) included in delivery

Three-dimensional climbing net cross

Ropes and nets made of Hercules rope (Ø 16 mm, 6-strand, with steel core)

Technical data

Equipment height: 2.20 m

Space requirement: 2.35 x 2.35 m

Safety zone: 5.35 x 5.35 m

Min. fall protection: 26.60 m²

Height of fall: 1.50 m

Ground surface: see table on page 275

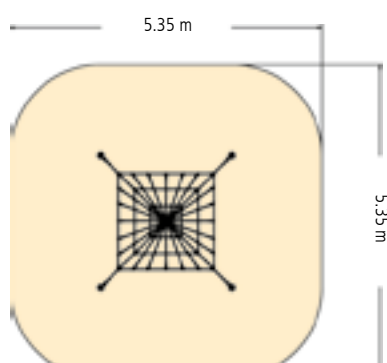



Easy-climb 4

Art.no. 4591-40-4

Equipment

2 steel posts (Ø 102 mm), hot-dip galvanised, length 2.40 m, with caps and fixing attachments, special paint (red) included in delivery

Climbing net in the shape of a gable roof

Ropes and nets made of Hercules rope (Ø 16 mm, 6-strand, with steel core)

Technical data

Equipment height:	1.60 m
Space requirement:	2.35 x 2.20 m
Safety zone:	4.70 x 4.60 m
Min. fall protection:	19.50 m ²
Height of fall:	1.50 m
Ground surface:	see table on page 275

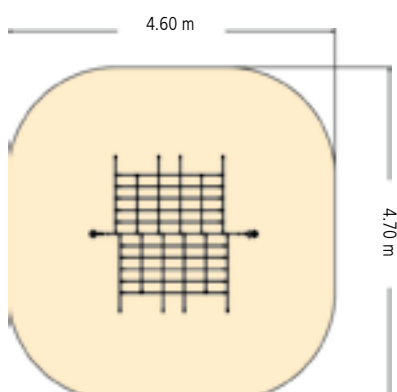



Witch's coven Version 1

Art. no. 4594-50 Douglas fir posts (Ø 160 mm), with post shoes

Art. no. 4594-50S steel posts (Ø 102 mm)

Equipment

Standard version: 11 Douglas fir posts (Ø 160 mm), in various lengths, with post shoes

2 rope ladders

2 horizontal triangle nets

1 triangle climbing net

1 lounging net

1 vertical climbing net

1 hanging rope with 2 loops

1 rubber climber with hanging rope

1 rope ladder

1 tyre net

2 tyres

1 rubber hammock

Ropes and nets made of Hercules rope (Ø 16 mm, 6-strand, with steel core)

Technical data

Equipment height: 1.60 m

Space requirement: 6.50 x 6.40 m

Safety zone: 9.80 x 9.00 m

Min. fall protection: 54.50 m²

Height of fall: 1.10 m

Ground surface: see table on page 275

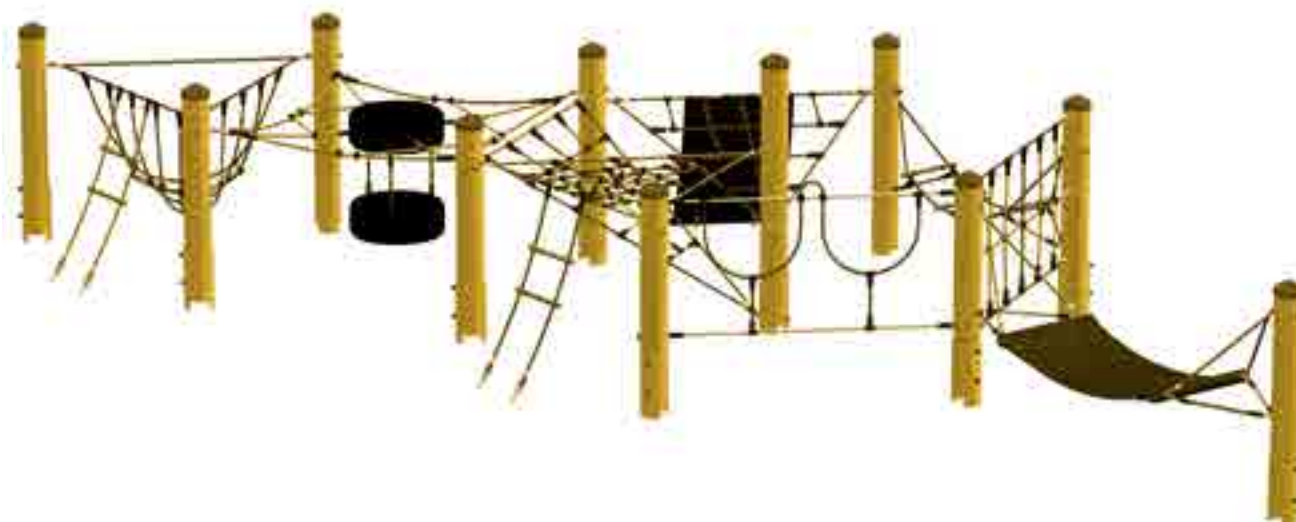
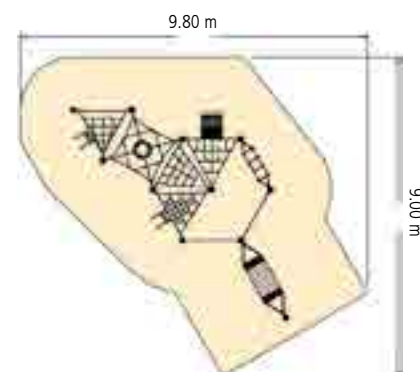

Witch's coven Version 2

Art. no. 4594-51 Douglas fir posts (Ø 160 mm), with post shoes

Art. no. 4594-51S steel posts (Ø 102 mm)

Equipment

Standard version: 8 Douglas fir posts (Ø 160 mm), in various lengths, with post shoes

1 rope ladder

2 horizontal triangle nets

1 triangle climbing net

1 vertical climbing net

1 hanging rope with 2 loops

1 rubber climber with hanging rope

1 rope ladder

1 rubber hammock

Ropes and nets made of Hercules rope (Ø 16 mm, 6-strand, with steel core)

Technical data

Equipment height: 1.60 m

Space requirement: 4.10 x 6.25 m

Safety zone: 7.25 x 9.00 m

Min. fall protection: 42.00 m²

Height of fall: 1.10 m

Ground surface: see table on page 275

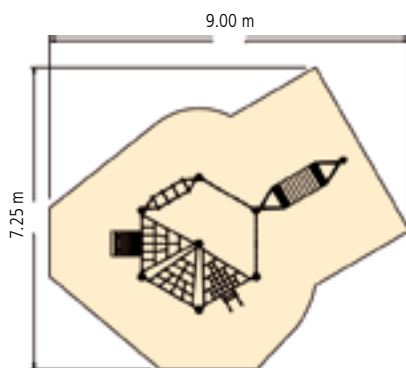
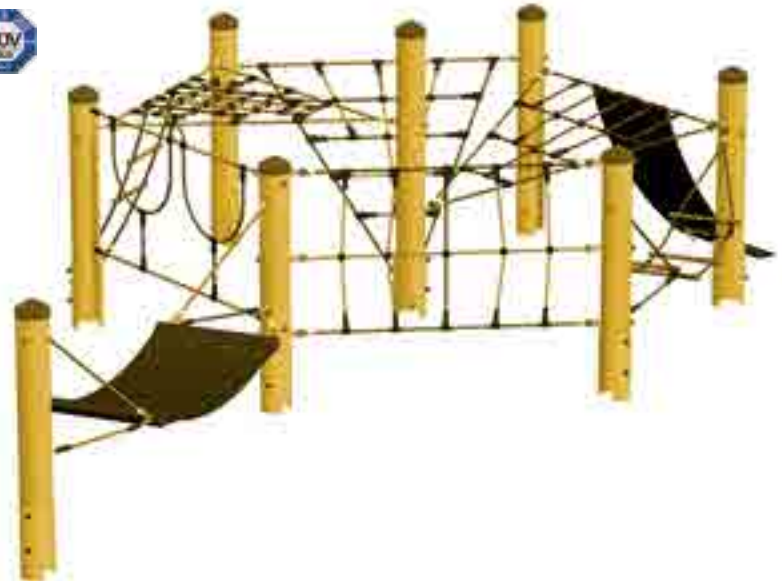

Witch's coven Version 3

Art. no. 4594-52 Douglas fir posts (Ø 160 mm), with post shoes

Art. no. 4594-52S steel posts (Ø 102 mm)

Equipment

Standard version: 5 Douglas fir posts (Ø 160 mm), in various lengths, with post shoes

1 rope ladder

1 lounging net

1 tyre net

2 tyres

Ropes and nets made of Hercules rope (Ø 16 mm, 6-strand, with steel core)

Technical data

Equipment height: 1.30 m

Space requirement: 3.40 x 1.95 m

Safety zone: 6.40 x 4.95 m

Min. fall protection: 27.00 m²

Height of fall: 1.10 m

Ground surface: see table on page 275

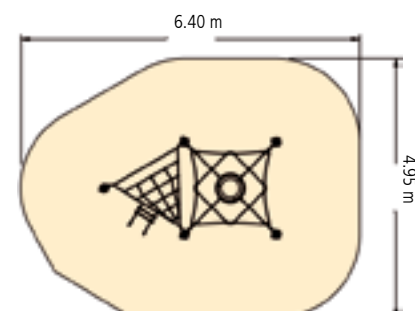
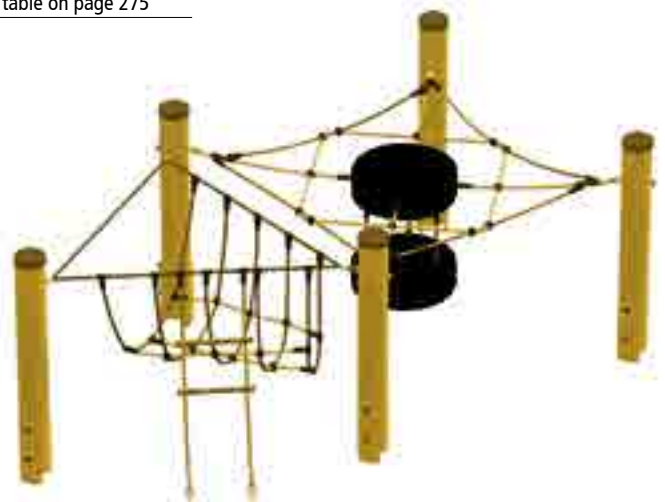



Witch's hiding place

Art.no. 4594-53

Equipment

7 steel posts (Ø102 mm), hot-dip galvanised, length 2.00 m, with cap, special paint (red) included in delivery

1 horizontal triangle net

1 angled climbing net

1 vertical climbing net

1 hanging and balancing rope

1 climbing ladder

1 radial network

1 tyre net

1 horizontal rope ladder

2 double rope ladders

1 corrugated rubber belt

Ropes made from Hercules rope (Ø 16 mm, 6-strand, with steel core)

Technical data

Equipment height: 1,0 m

Space requirement: 4.30 x 4.10 m

Safety zone: 7.30 x 7.10 m

Min. fall protection: 40.00 m²

Height of fall: 1.20 m

Ground surface: see table on page 275

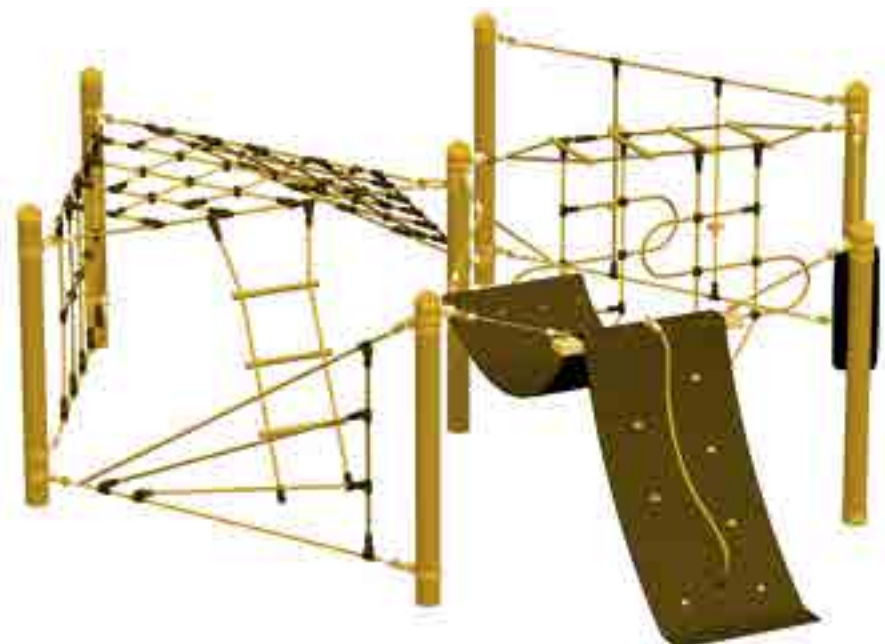
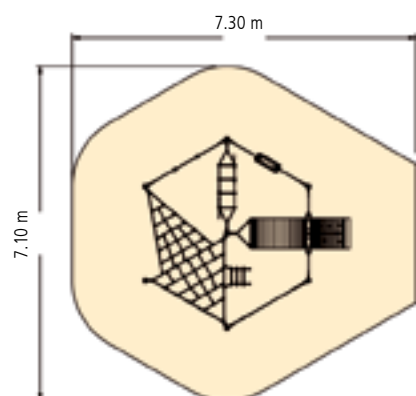



Spider web net

Art. no. 45975 Steel posts

Art. no. 4597 Natural oak posts

Equipment

Standard version: Steel posts (Ø 102 mm), hot-dip galvanised, length 3.00 m, with caps, special paint (blue) included in delivery

Angled spider web net

Made from Hercules rope (Ø 16 mm, 6-strand, with steel core)

Technical data

Equipment height: 2.00 m

Space requirement: Ø 3.80 m

Safety zone: Ø 6.80 m

Min. fall protection: 36.25 m²

Height of fall: 1.50 m

Ground surface: see table on page 275

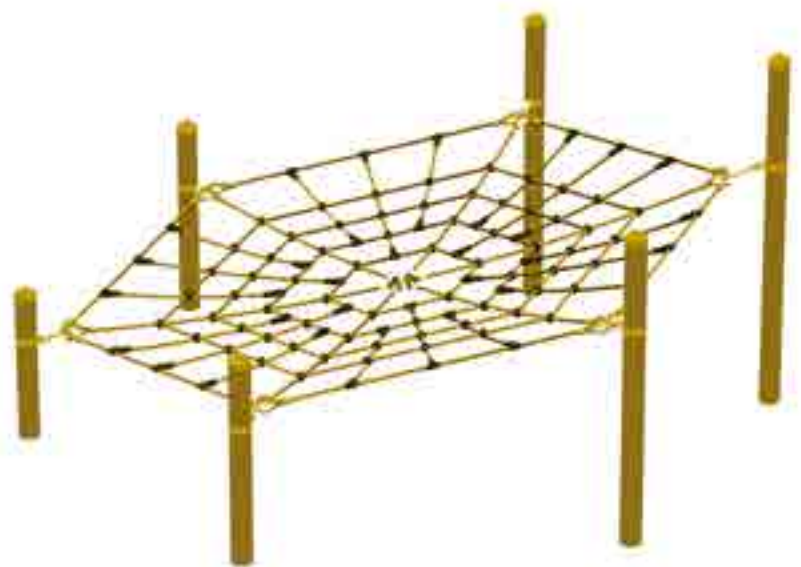
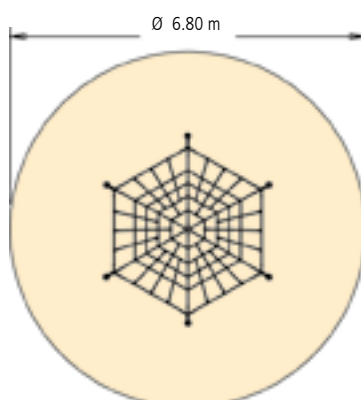



Mini hexagon climbing castle

Art.no. 4587-20

Equipment

Hexagon frame construction with 6 steel posts (Ø 102 mm), hot-dip galvanised, length 3.00 m, special paint (blue) included in delivery

1 spider-web net

1 HUCK honeycomb nest (Ø 1.00 m) with suspension ropes

3 transition nets

2 triangle holding rungs

1 climbing ladder

1 suspension rope with balancing rope

1 Garland clamber rope

Ropes and nets made of Hercules rope (Ø 16 mm, 6-strand, with steel core)

Technical data

Equipment height: 1.60 m

Space requirement: Ø 3.10 m

Safety zone: 6.20 x 5.80 m

Min. fall protection: 28.50 m²

Height of fall: 1.60 m

Ground surface: see table on page 275

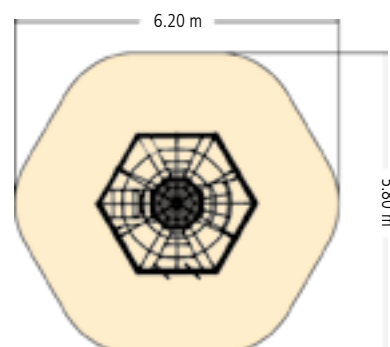

Hexagonal Maxi climbing castle 
(page 56)



Climbing star

Art.no. 4594-36

Equipment

1 steel post (Ø 102 mm), hot-dip galvanised, length 3.00 m, with plastic cap, special paint (red) included in delivery

1 original HUCK Bird's Nest® (Ø 1.20 m)

1 climbing net

4 suspension ropes

Ropes and nets made of Hercules rope (Ø 16 mm, 6-strand, with steel core)

Technical data

Equipment height: 2.10 m

Space requirement: Ø 3.80 m

Safety zone: 5.80 x 5.65 m

Min. fall protection: 25.10 m²

Height of fall: 1.25 m

Ground surface: see table on page 275

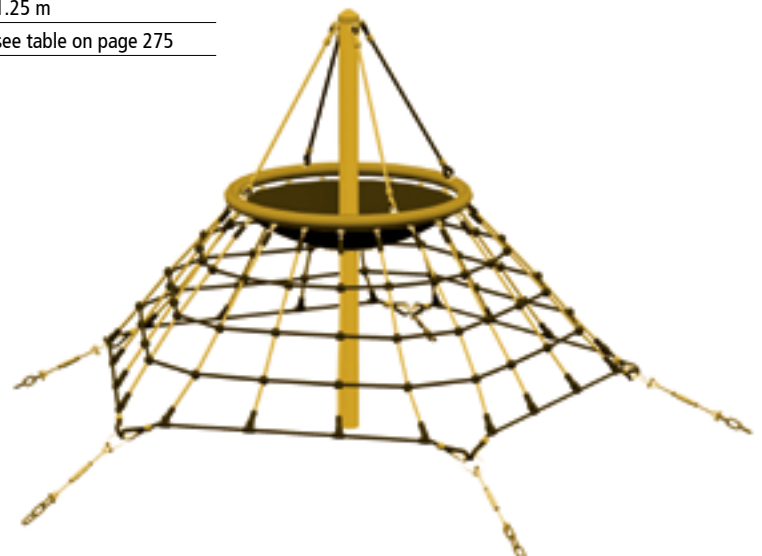
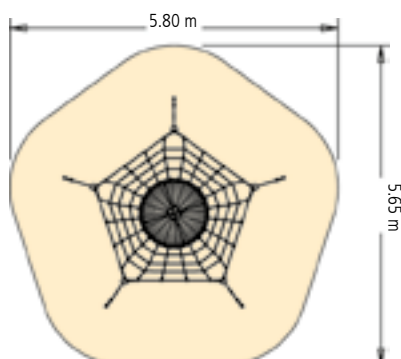

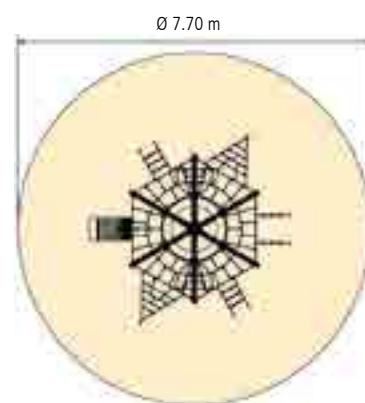

Mini pirate tower

Art.no. 4687-30

Equipment

1 steel mast (Ø 160 mm), hot-dip galvanised, length 4.70 m, 6 horizontal steel girders (Ø 102 mm), hot-dip galvanised, special paint (blue) included in delivery

1 circular hanging net

3 climbing ropes

2 rope ladders

1 rubber climber

2 triangle climbing nets

2 net seats

Ropes and nets made of Hercules rope (Ø 16 mm, 6-strand, with steel core)

Technical data

Equipment height: 3.70 m

Space requirement: Ø 4.70 m

Safety zone: Ø 7.70 m

Min. fall protection: 46.50 m²

Height of fall: 1.50 m

Ground surface: see table on page 275

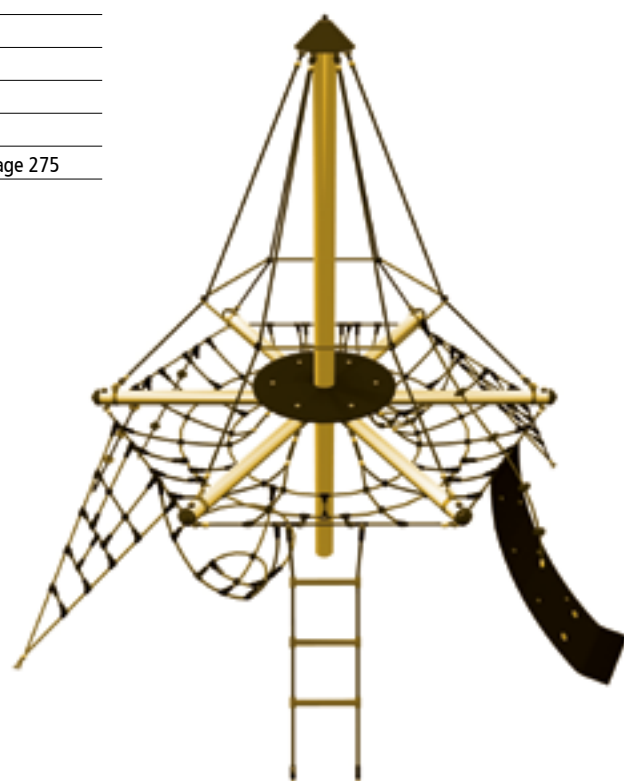

"Fortuna" mini pirate tower

(page 15)

"Störtebeker" pirate tower

(page 80)





“Fortuna” play course

Art.no. 4591-65

Equipment

- 1 steel post (Ø 102 mm), length 3.00 m, 2 steel posts (Ø 102 mm), length 2.40 m, hot-dip galvanised, with plastic caps, special paint (red) included in delivery
- 2 original HUCK Bird's Nests® (Ø 1.20 m)
- 1 steel ring wound round with rope (Ø 1.20 m)
- 1 balancing rope, PP (Ø 65 mm), with suspension ropes
- 1 horizontal ladder with plastic rungs
- 1 horizontal rubber belt with climbing aids
- 2 horizontal rope ladders with plastic rungs
- 1 climbing net
- Ropes and nets made of Hercules rope (Ø 16 mm, 6-strand, with steel core)

Technical data

Equipment height:	2.00 m
Space requirement:	3.80 x 3.45 m
Safety zone:	6.80 x 6.45 m
Min. fall protection:	33.50 m ²
Height of fall:	max. 1.00 m
Ground surface:	see table on page 275



Also possible as a double design too!

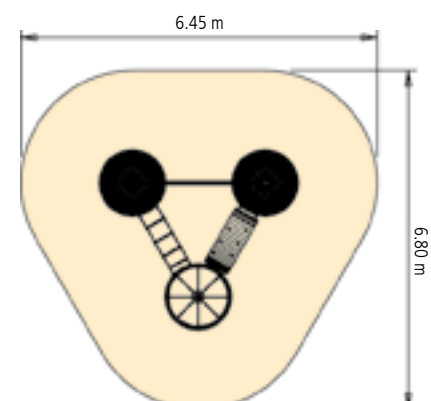



Tower bridge

Art.no. 4960-11

Equipment

2 steel posts (Ø 102 mm), length 3.00 m, hot-dip galvanised, with plastic caps, special paint (blue) included in delivery

2 original HUCK Bird's Nests® (Ø 1.20 m)

4 climbing ladders

1 arched bridge

Ropes and nets made of Hercules rope (Ø 16 mm, 6-strand, with steel core)

Technical data

Equipment height: 2.50 m

Space requirement: 6.25 x 2.40 m

Safety zone: 9.25 x 5.40 m

Min. fall protection: 41.35 m²

Height of fall: 1.70 m

Ground surface: see table on page 275

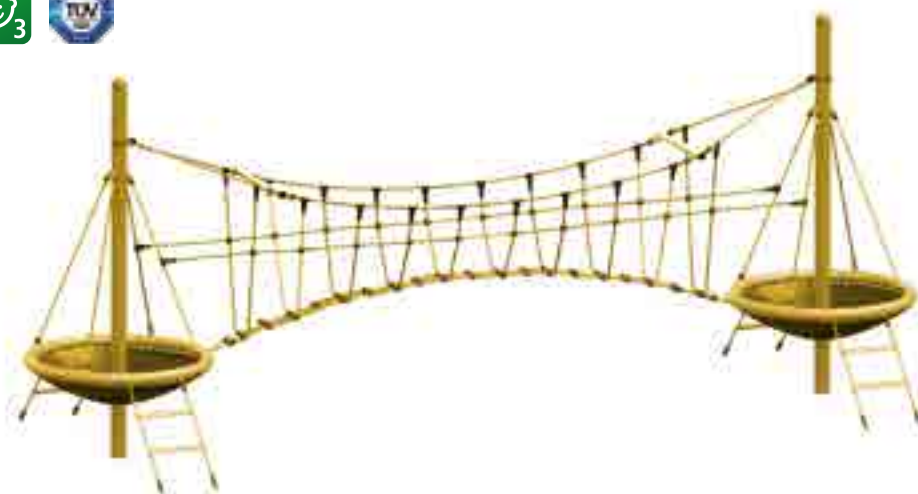
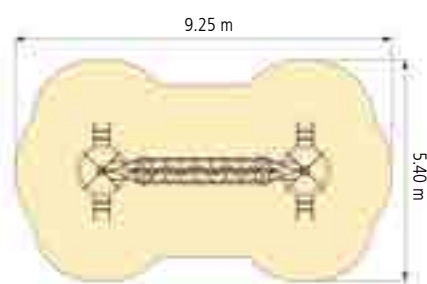



“Wobble rung” adventure bridge

Art.no. 4959-50

Equipment

4 steel posts (Ø 102 mm), hot-dip galvanised, length 2.00 m, with plastic caps, special paint (blue) included in delivery

1 net bridge with plastic rungs as walkway, length 3.00 m

Ropes and nets made of Hercules rope (Ø 16 mm, 6-strand, with steel core)

Technical data

Equipment height:	1.20 m
Space requirement:	3.10 x 1.10 m
Safety zone:	6.10 x 4.10 m
Min. fall protection:	23.00 m ²
Height of fall:	0.50 m
Ground surface:	see table on page 275

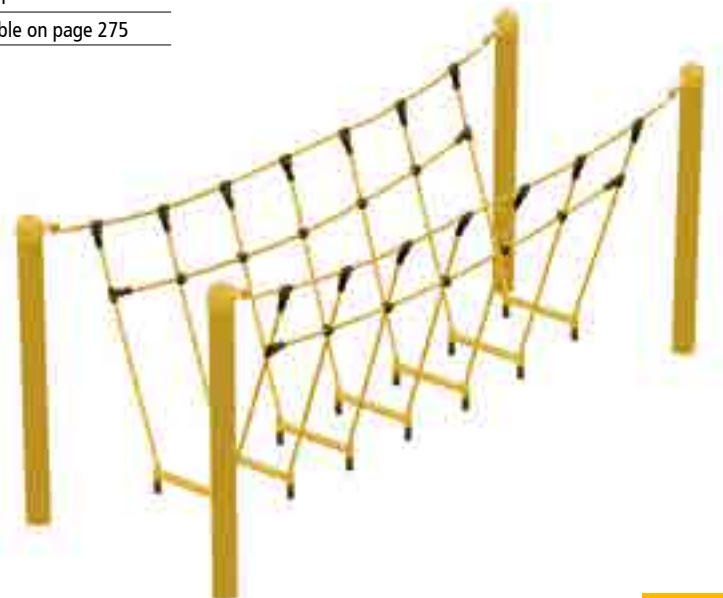
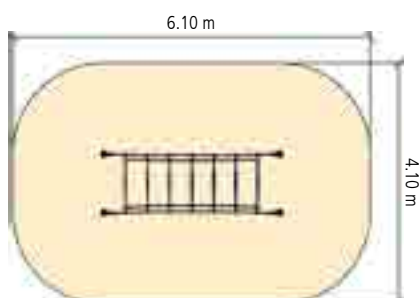



“Wooden catwalk” adventure bridge

Art.no. 4959-20

Equipment

4 steel posts (Ø 100 mm), hot-dip galvanised, length 2.00 m, with caps and fixing attachments, special paint (blue) included in delivery

Running surface made from larch rungs

Metal parts made of stainless steel or hot-dip galvanised

Ropes and nets made of Hercules rope (Ø 16 mm, 6-strand, with steel core)

Technical data

Equipment height:	1.20 m
Space requirement:	3.10 x 1.10 m
Safety zone:	6.10 x 4.10 m
Min. fall protection:	23.00 m ²
Height of fall:	0.80 m
Ground surface:	see table on page 275

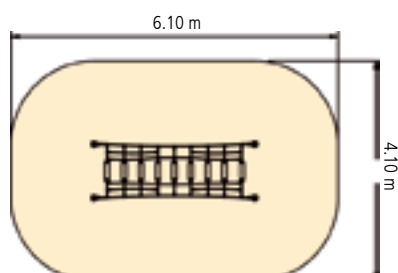



“Climbing wall” adventure bridge

Art.no. 4959-81

Equipment

4 steel posts (Ø 102mm), hot-dip galvanised
1.30 m, Length 2.00m with plastic caps, special
colour paint (Blue) supplied

3 climbing elements made from HDPE boards

1 HDPE disc seat with grip bars

Hercules ropes and nets
(Ø 16mm, 6-strand, with steel core)

Technical data

Equipment height: 1.30 m

Space requirement: 3.10 x 1.10 m

Safety zone: 6.10 x 4.10 m

Min. fall protection: 23.00 m²

Height of fall: 0.98 m

Ground surface: see table on page 275

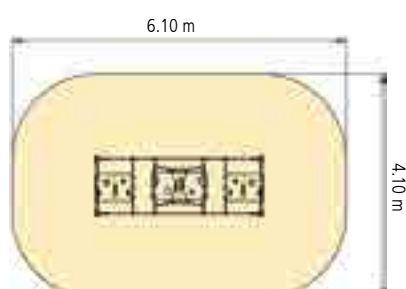

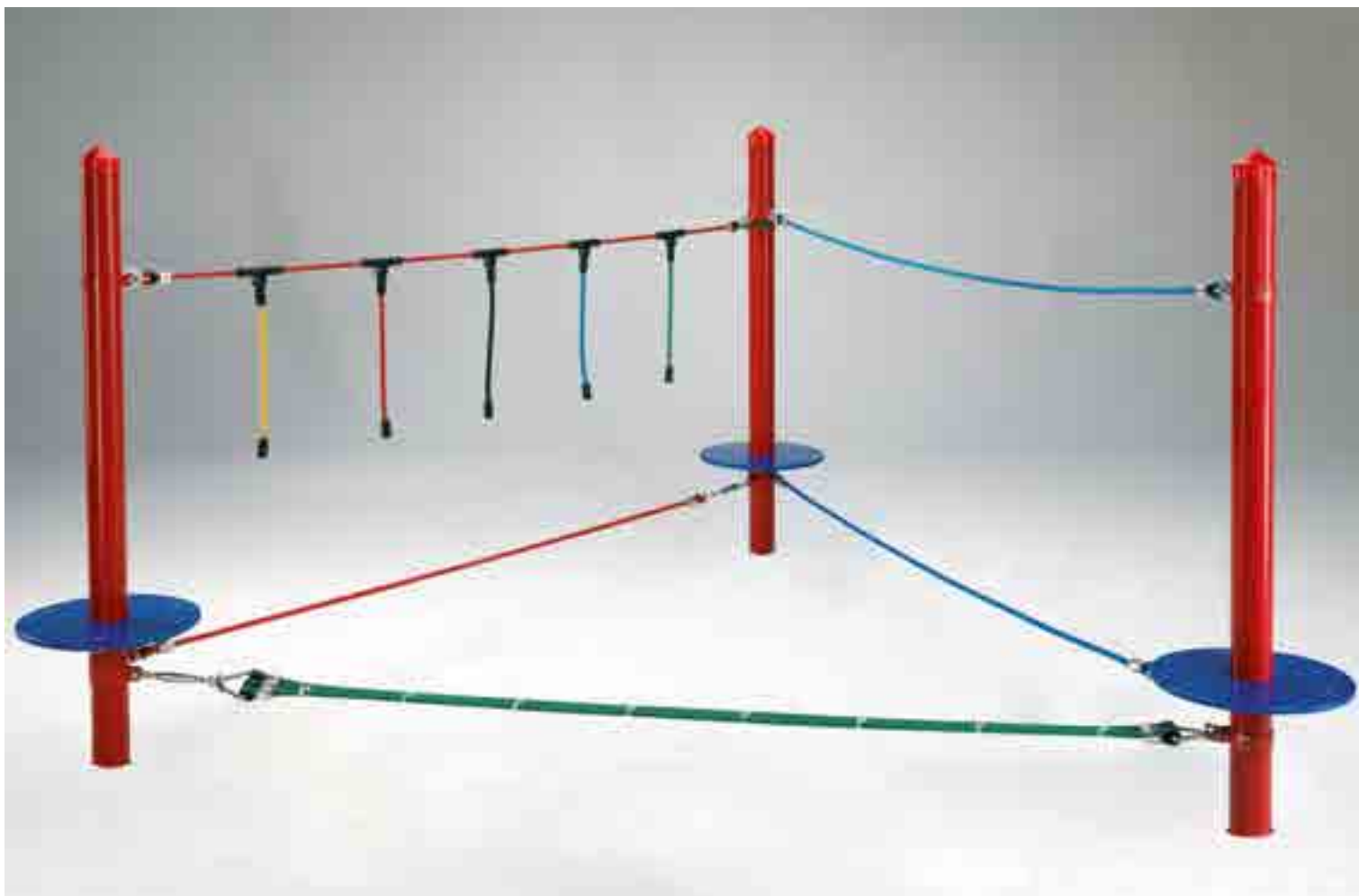

Slackmaster

Art.no. 4591-70-k

Elements also available individually and in different lengths!

Equipment

3 steel posts (Ø 102 mm), hot-dip galvanised, length 2.40 m, with plastic cap and PE base, special paint (red) included in delivery

1 slackline balancing element

1 holding and balancing element

1 holding and balancing element with vertical ropes

Ropes made from Hercules rope (Ø 16 mm, 6-strand, with steel core)

Technical data

Equipment height:	1.60 m
Space requirement:	3.55 x 4.10 m
Safety zone:	6.10 x 6.50 m
Min. fall protection:	29.50 m ²
Height of fall:	0.40 m
Ground surface:	see table on page 275

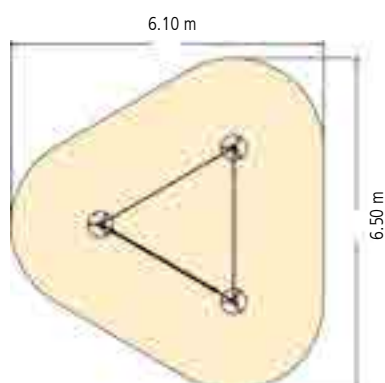



Slackmaster combination 1

Art.no. 4591-71

Equipment

4 steel posts (Ø 102 mm), length 2.00 m, hot-dip galvanised, with plastic caps, special paint (blue) included in delivery

Plastic platform (HDPE) (Ø 500 mm)

1 steel ring wound round with rope (Ø 1.20 m)

1 slackmaster balancing element

Ropes and nets made of Hercules rope (Ø 16 mm, 6-strand, with steel core)

Technical data

Equipment height: 1.20 m

Space requirement: 4.05 x 4.05 m

Safety zone: 7.05 x 7.05 m

Min. fall protection: 47.00 m²

Height of fall: 0.60 m

Ground surface: see table on page 275

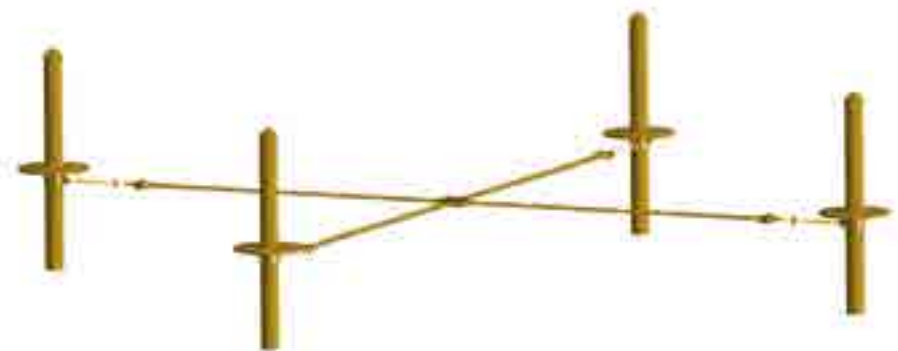
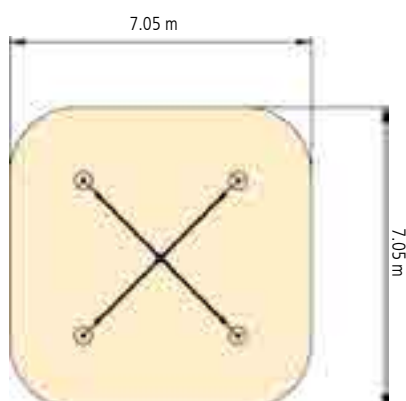



Slackmaster combination 2

Art.no. 4591-72

Equipment

4 steel posts (Ø 102 mm), length 3.00 m, hot-dip galvanised, with plastic caps, special paint (blue) included in delivery

Plastic platform (HDPE) (Ø 500 mm)

1 hanging and balancing element with clambering loops

1 clambering element with clambering loops

1 hanging and balancing element with garland clamber rope

1 slackline climbing net

1 slackmaster balancing element

Ropes and nets made of Hercules rope (Ø 16 mm, 6-strand, with steel core)

Technical data

Equipment height: 2.20 m

Space requirement: 3.50 x 3.50 m

Safety zone: 6.50 x 6.50 m

Min. fall protection: 39.70 m²

Height of fall: 0.80 m

Ground surface: see table on page 275

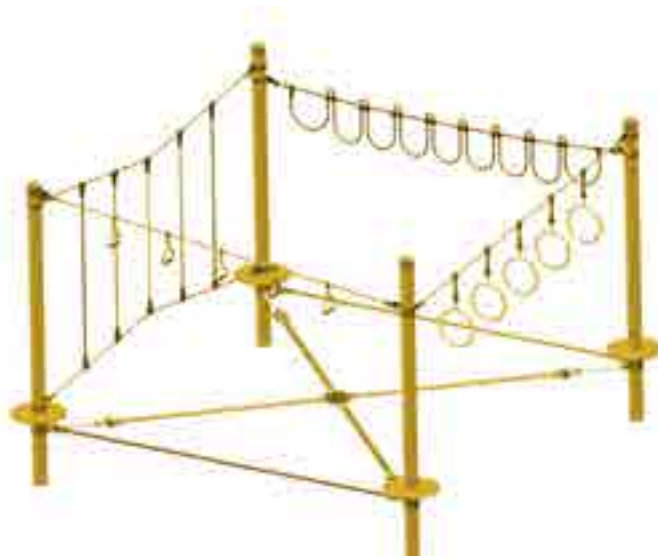
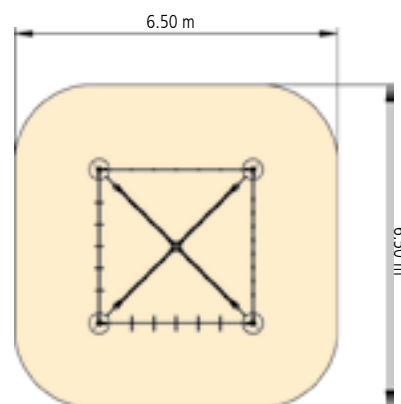

Rope play equipment for children over the age of 4



HUCK rope play equipment provides a suitable play environment for every age group and boosts fantasy and fine motor skills in a playful way. They encourage childrens' natural need for movement with a multitude of possible combinations. Individual items of equipment also blend harmoniously into virtually any adventure landscape. All play systems can be combined with various possible climbing elements such as climbing nets, net ramps, rope ladders or rubber flooring. The play systems also come with a wide range of different structural design elements in every shape and colour. Whether they have a slide, swing or climbing chimney – fun is guaranteed! HUCK provides, for instance, practical buried ground anchors and assembly solutions for flat roofs so that erecting the equipment becomes child's play.

| 52 |

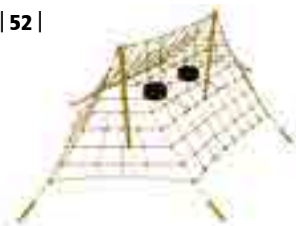

Tent net

| 53 |

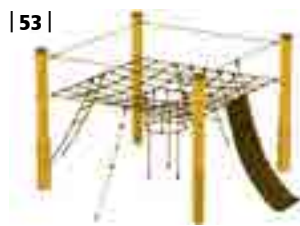

Sky castle

| 54 |



Pirate castle

| 55 |

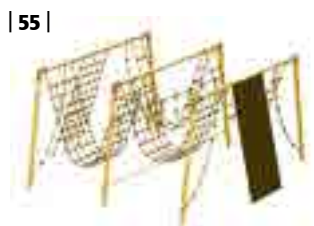

Up & over

| 56 |



Maxi hexagon climbing castle

| 57 |

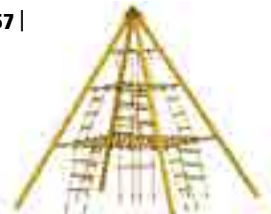

Midi climbing teepee

| 58 |



Look-out

| 59 |



Diablo

| 60 |



Net seesaw

| 61 |



Net seesaw

| 62 |



SlackRope

| 63 |



Tightrope

| 64 |



Lantern nests



Tent net

Art. no. 4639-10 European design patent

Equipment

2 steel masts (Ø 102 mm), hot-dip galvanised, length 3.40 m, special paint (red) included in delivery

1 tent net with tension cords

2 tyre swings

Made from Hercules rope (Ø 16 mm, 6-strand, with steel core)

Technical data

Equipment height: 2.60 m

Space requirement: 8.60 x 5.60 m

Safety zone: 10.05 x 7.05 m

Min. fall protection: 54.00 m²

Height of fall: 2.00 m

Ground surface: see table on page 275

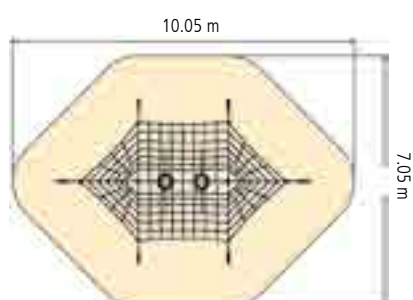



Sky castle

Art. no. 4638 Oak posts (Ø 160 mm), with steel safety plates

Art. no. 4638S Steel posts (Ø 102 mm)

Art. no. 4638PS Douglas fir posts (Ø 180 mm), with post shoes

Equipment

Standard version: 4 oak posts (Ø 160 mm),
varnished, length 3.00 m, with steel safety plates

1 horizontal net with net chimney

1 rubber floor climber

1 rope ladder

1 climbing net

Ropes and nets made of Hercules rope
(Ø 16 mm, 6-strand, with steel core)

Technical data

Equipment height: 2.20 m

Space requirement: Ø 4.30 m

Safety zone: Ø 7.30 m

Min. fall protection: 42.00 m²

Height of fall: 1.50 m

Ground surface: see table on page 275

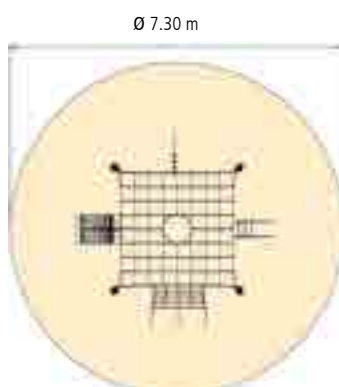



Pirate castle

Art. no. 4687 Oak posts (Ø 160 mm), with steel safety plates

Art. no. 4687S Steel posts (Ø 102 mm)

Art. no. 4687PS Douglas fir posts (Ø 180 mm), with post shoes

Equipment

Standard version: 3 oak posts (Ø 160 mm), varnished, length 3.00 m, with steel safety plates

1 triangle climbing net

1 rubber climber

1 rope ladder

1 horizontal net

Ropes and nets made of Hercules rope (Ø 16 mm, 6-strand, with steel core)

Technical data

Equipment height: 2.20 m

Space requirement: 3.50 x 3.40 m

Safety zone: 6.50 x 6.40 m

Min. fall protection: 35.00 m²

Height of fall: 1.50 m

Ground surface: see table on page 275

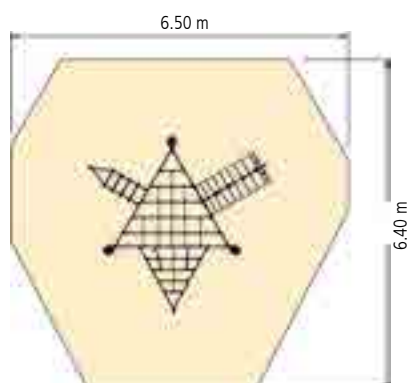



Up & over

Art.no. 4587-10

Equipment

6 steel posts (Ø 102 mm), hot-dip galvanised, length 3.60 m, special paint (blue or red) included in delivery

3 steel cross beams (Ø 102 mm), hot-dip galvanised, length 4.15 m, special paint (blue or red) available for an additional charge

1 climbing net

2 horizontal rope ladders with plastic rungs

2 bed nets

4 angled climbing ropes

1 balancing rope

1 hanging rope with vertical suspension ropes

1 climbing wall with climbing handles

Ropes and nets made of Hercules rope (Ø 16 mm, 6-strand, with steel core)

Technical data

Equipment height: 2.65 m

Space requirement: 5.50 x 5.25

Safety zone: 8.55 x 8.95 m

Min. fall protection: 72.00 m²

Height of fall: 2.65 m

Ground surface: see table on page 275

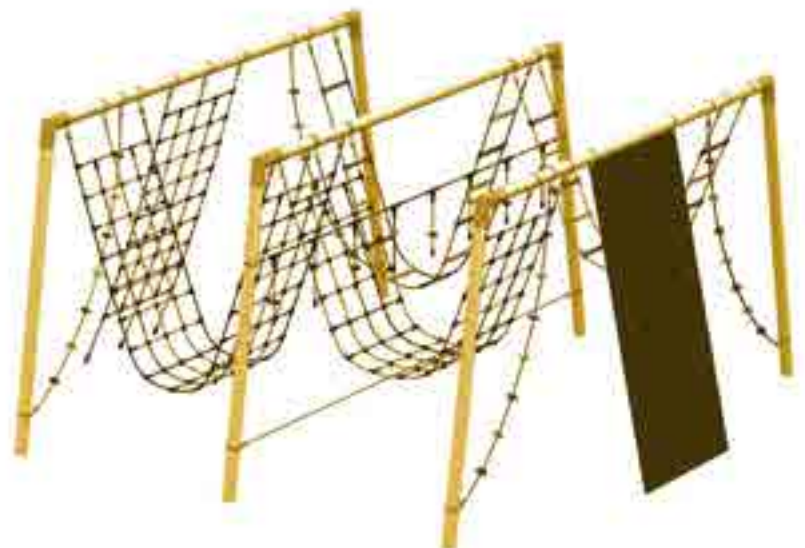
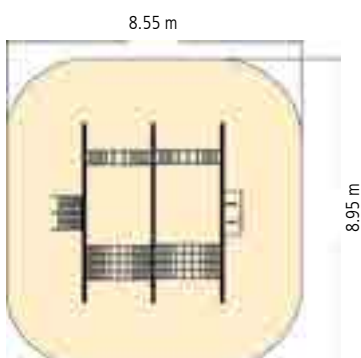



Maxi hexagon climbing castle

Art.no. 4587-21

 Hexagonal mini climbing castle (page 40)

Equipment

Hexagon frame construction with 6 steel posts (Ø 102 mm), hot-dip galvanised, length 2.30 m, special paint (blue) included in delivery

1 spider-web net

1 triangle climbing net

1 glulam climbing wall with climbing handles

1 original mini HUCK Bird's Nest® with suspension ropes

2 rope ladders with plastic rungs

3 transition nets

1 rubber hammock

Ropes and nets made of Hercules rope (Ø 16 mm, 6-strand, with steel core)

Technical data

Equipment height: 2.30 m

Space requirement: 3.45 x 6.10 m

Safety zone: 7.20 x 9.10 m

Min. fall protection: 44.00 m²

Height of fall: 2.30 m

Ground surface: see table on page 275

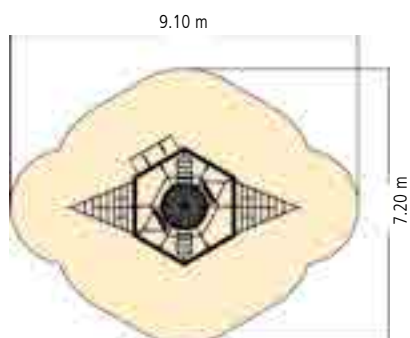



Midi climbing teepee

Art.no. 4587-22

[Maxi climbing wigwam \(page 82\)](#)

Equipment

4 steel posts (Ø 102 mm), length 5.00 m, hot-dip galvanised, special paint (blue) included in delivery

1 top plate

2 horizontal net bases

8 rope ladders

1 climbing chimney

Ropes and nets made of Hercules rope (Ø 16 mm, 6-strand, with steel core)

Technical data

Equipment height: 3.60 m

Space requirement: 3.35 x 3.35 m

Safety zone: 5.90 x 5.90 m

Min. fall protection: 32.45 m²

Height of fall: 2.15 m

Ground surface: see table on page 275

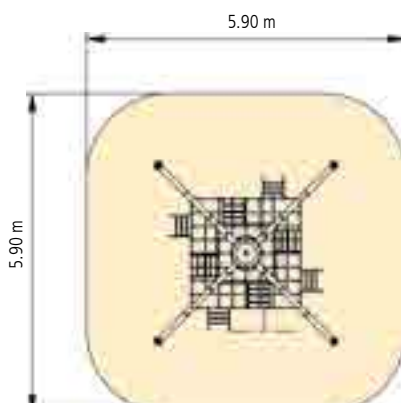



Look-out

Art.no. 4592-10

Equipment

Steel mast (Ø 160 mm), hot-dip galvanised, length 5.00 m, cap, special paint (blue or red) available for an additional charge

Internal rope climbing ladder and climbing rope with climbing aids

1 original HUCK Bird's Nest® (Ø 1.40 m)

Metal parts made of stainless steel or hot-dip galvanised

Nets made from Hercules rope (Ø 16 mm, 6-strand, with steel core)

Technical data

Equipment height:	4.15 m
Space requirement:	Ø 2.00 m
Safety zone:	Ø 5.80 m
Min. fall protection:	26.50 m ²
Height of fall:	2.10 m
Ground surface:	see table on page 275

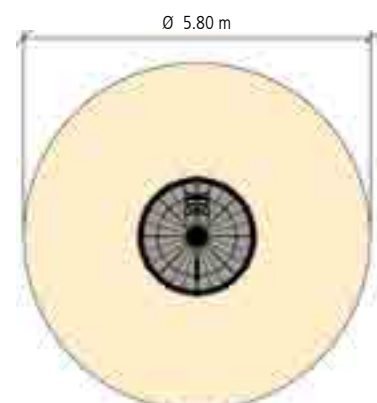



Diablo

Art.no. 4592-20

Equipment

1 steel mast (Ø 127 mm), hot-dip galvanised, length 3.80 m

1 spinning shoe

2 steel rings wound round with rope (Ø 1.80 m), galvanised, with net base

1 funnel net

4 climbing ropes

Ropes made from Hercules rope (Ø 16 mm, 6-strand, with steel core)

Technical data

Equipment height: 2.90 m

Space requirement: Ø 1.90 m

Safety zone: Ø 7.00 m

Min. fall protection: 38.50 m²

Height of fall: 2.00 m

Ground surface: see table on page 275



Hourglass
(page 83)

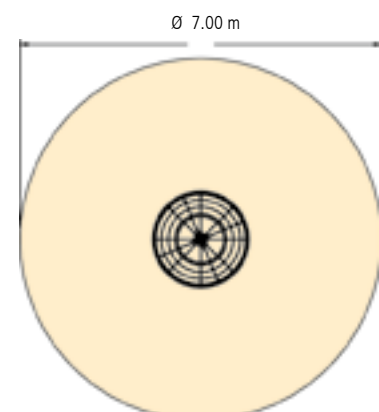



Net seesaw

Art.no. 4587

Equipment

- 2 laminated douglas fir seesaw beams (Ø 180 mm)
- 1 seesaw mechanism
- 1 horizontal climbing net
- 2 stainless steel grip bars
- 2 suspension ropes
- 2 rubber tyres

Ropes and nets made of Hercules rope (Ø 16 mm, 6-strand, with steel core)

Technical data

Equipment height:	1.40 m
Space requirement:	4.00 x 0.90 m
Safety zone:	6.40 x 3.30 m
Min. fall protection:	20.10 m ²
Height of fall:	1.20 m
Ground surface:	see table on page 275

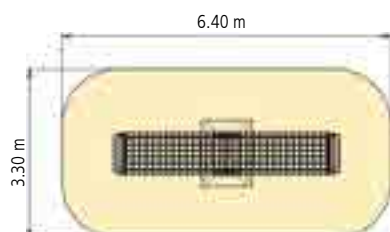



Steel net seesaw

Art.no. 45875

Equipment

1 steel seesaw frame (Ø 102mm) Hot-dip galvanized and painted (RAL 7016 anthracite-grey)
 1 horizontal climbing net
 2 holding grips
 2 rope handrails
 2 rubber tyres
 Hercules ropes and nets
 (Ø 16mm, 6 strand, with steel core)

Technical data

Equipment height:	1.40 m
Space requirement:	4.20 x 0.80 m
Safety zone:	6.40 x 3.30 m
Min. fall protection:	20.10 m ²
Height of fall:	1.20 m
Ground surface:	see table on page 275

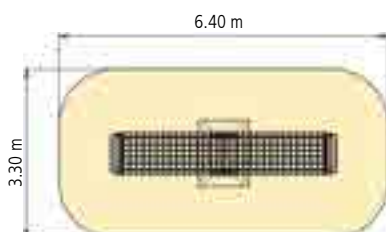



SlackRope

Art.no. 4591-80

Equipment

Rope-wound, Ø 65 mm, length 5.50 m

2 suspension springs

Ropes and nets made of Hercules rope (Ø 16 mm, 6-strand, with steel core)

Technical data

Equipment height: 0.40 m

Space requirement: 5.35 x 0.10 m

Safety zone: 8.35 x 3.00 m

Min. fall protection: 23.10 m²

Height of fall: 0.40 m

Ground surface: see table on page 275





Tightrope

Art.no. 4591-73

Equipment

2 solid steel standing frames (Ø 102mm),
T-shaped, hot-dip galvanised, Special paint
(Blue) available for surcharge

1 horizontal rope-ladder

1 slackline balancing element

1 supplemental mechanism

Hercules ropes and nets
(Ø 16mm, 6 strand, with steel core)

Technical data

Equipment height: 0.64 m

Space requirement: 6.42 x 1.00 m

Safety zone: 9.42 x 4.00 m

Min. fall protection: 35.50 m²

Height of fall: 0.64 m

Ground surface: see table on page 275

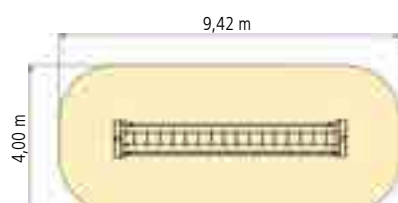



Lantern climbing nest

Art.no. 4530-20

Equipment

1 steel posts (Ø 160 mm), hot-dip galvanised, length 3.50 m, special paint (red) included in delivery

HUCK honeycomb nest with ground anchor

1 universal joint (art. 4608-2)

Ropes and nets made of Hercules rope (Ø 16 mm, 6-strand, with steel core)

Technical data

Equipment height: 2.50 m

Space requirement: 1.00 x 2.40 m

Safety zone: Ø 4.30 m

Min. fall protection: 14.50 m²

Height of fall: 1.50 m

Ground surface: see table on page 275

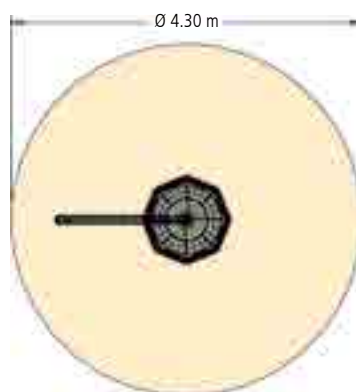

Lantern swing nest

Art.no. 4530-50

Equipment

1 steel posts (Ø 160 mm), hot-dip galvanised, length 3.50 m, special paint (red) included in delivery

Dish swing with wooden base and ground anchor

Suspension chains with sleeve

1 universal joint (art. 4608-2)

Technical data

Equipment height: 2.50 m

Space requirement: 1.00 x 2.40 m

Safety zone: Ø 4.30 m

Min. fall protection: 14.50 m²

Height of fall: 0.60 m

Ground surface: see table on page 275

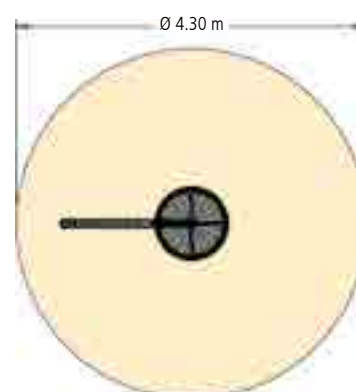

Rope play equipment for children over the age of 6



Children change their interests, at the latest when they start going to school. With their interesting features and a multitude of possible combinations, HUCK rope play equipment therefore entices children to keep moving outdoors. Higher constructions, adventure bridges, balancing sections and much more provide a play environment that suits an older age. All play systems can be combined with various possible climbing elements such as climbing nets, net ramps, rope ladders or rubber flooring. The play systems also come with a wide range of different structural design elements in every shape and colour. Whether they have a slide, swing or climbing chimney – fun is guaranteed!



| 66 |

Launch pad

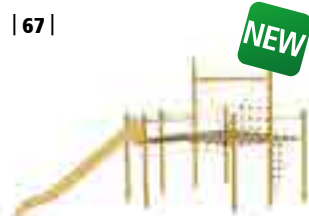

| 67 |

Midi play ship

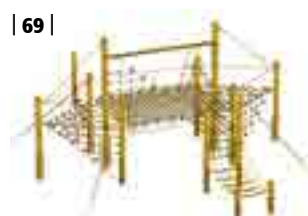

| 69 |

Play ship



| 71 |

Bird's nest tree

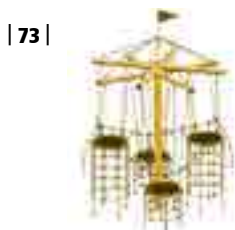

| 73 |

Midi bird's nest tree



| 75 |

Eagles nest tree

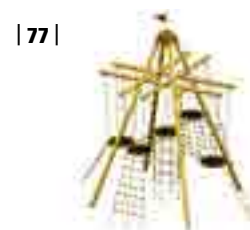

| 77 |

Bird's nest tower



| 79 |

"Black forest" birds nest tower



| 80 |

Pirate tower



| 81 |

"Black Beard" pirate ship

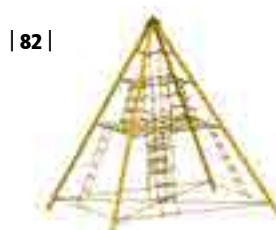

| 82 |

Maxi climbing teepee



| 83 |

Hourglass



| 84 |

Spinning mushroom



Launch pad

Art.no. 4631-10PS

Integrated slide upon request!
(page 279)

Equipment

Douglas fir posts (Ø 200-250 mm), in various lengths, with post shoes

1 trapeze climbing net

1 flat net with net chimney

1 triangle climbing net

1 vertical climbing net

1 hanging rope set

2 climbing ropes

1 V-bridge

Ropes and nets made of Hercules rope (Ø 16 mm, 6-strand, with steel core)

Technical data

Equipment height: 5.80 m

Space requirement: 13.20 x 10.00 m

Safety zone: 16.20 x 12.00 m

Min. fall protection: 122.00 m²

Height of fall: 2.80 m

Ground surface: see table on page 275

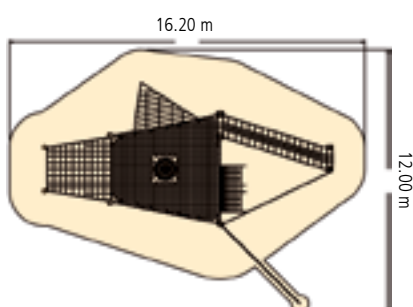



Midi play ship

Art.no. 4631-215

Picture with additional spiders web (optional extra)

Equipment

Steel posts (Ø 102mm), hot-dip galvanised in diff. lengths

1 horizontal net

1 sail net

1 entry ladder

1 double rope ladder

1 rung ladder with crossbeams

1 climbing wall

1 passage net

1 GRP slide

Hercules ropes and nets (Ø 16mm, 6 strand, with steel core)

Technical data

Equipment height: 4.00 m

Space requirement: 7.50 x 3.50 m

Safety zone: 11.90 x 8.15 m

Min. fall protection: 67.50 m²

Height of fall: 1.75 m

Ground surface: see table on page 275

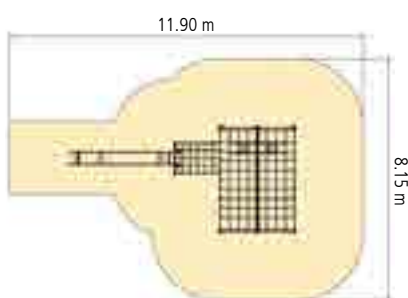





Play ship

Art. no. 4631-20 Oak posts with steel safety plates

Art. no. 4631-20PS Posts made from Douglas fir with post shoes

Equipment

Standard version: Oak posts (\varnothing 160/200 mm), varnished, in various lengths, with steel safety plates

4 side and 2 horizontal bow nets

1 horizontal net

1 sail net

1 climbing net

1 double rope ladder

1 rung ladder with crossbeam

1 hammock

Ropes and nets made of Hercules rope (\varnothing 16 mm, 6-strand, with steel core)

Technical data

Equipment height: 4.00 m

Space requirement: 7.62 x 10.25 m

Safety zone: 11.10 x 12.95 m

Min. fall protection: 95.5 m²

Height of fall: 1.75 m

Ground surface: see table on page 275



Integrated slide upon request (page 279)







Foto: Wicksteed Playscapes

Bird's nest tree

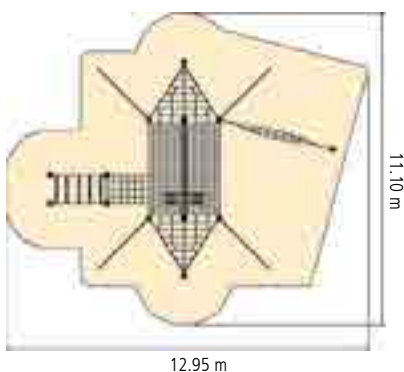
Art. no. 4652 European design patent

Equipment

Steel mast (Ø 193.70 mm), hot-dip galvanised, length 6.20 m, with mast cap, special paint (blue or red) available for an additional charge

High-quality varnished glulam as cross pieces

4 original HUCK Bird's Nests® with connecting ladders

2 climbing nets

5 climbing ropes

2 climbing chimneys

Various loop ropes and hanging ropes

Ropes and nets made of Hercules rope (Ø 16 mm, 6-strand, with steel core)

Technical data

Equipment height: 6.00 m

Space requirement: Ø 8.00 m

Safety zone: Ø 11.00 m

Min. fall protection: 95.50 m²

Height of fall: 2.80 m

Ground surface: see table on page 275



TRIED AND TESTED 100 TIMES!

The ideal break-time equipment for the school playground!

Upon request the cross beams can also be created in galvanised steel (Page 274)

Additional elements, such as a slide, can be added!

Mini birds nest tree (page 17)
 Midi birds nest tree (page 73)

Ø 11.00 m

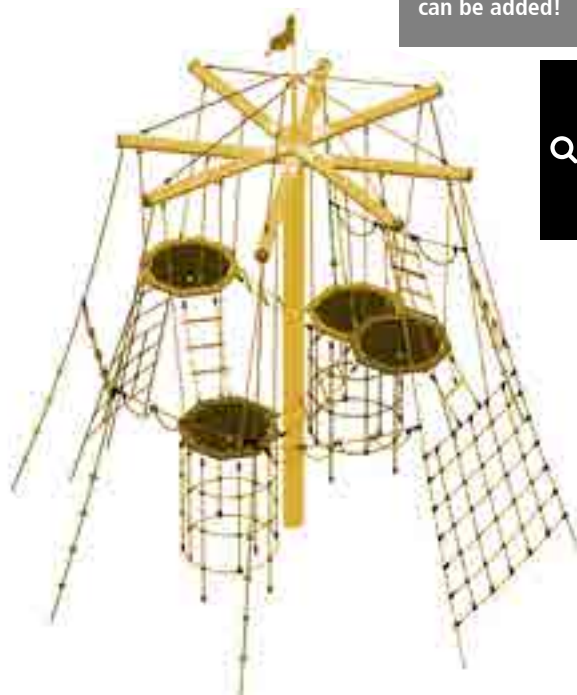
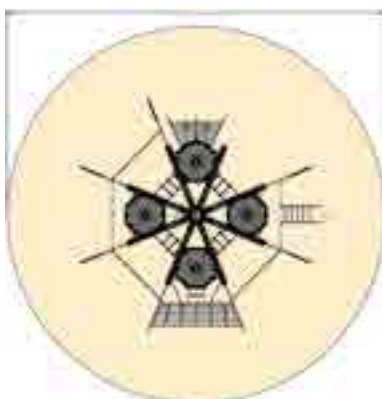





also be created in galvanised steel
(Page 274)!

Additional elements, such as a slide,
can be added

Q Mini birds nest tree
(page 17)
Birds nest tree
(page 71)

Midi bird's nest tree

Art.no. 4652-10

Equipment

Steel mast (Ø 193 mm), hot-dip galvanised,
length 5.30 m, with mast cap, special paint (blue
or red) available for an additional charge

High-quality varnished glulam as cross pieces

4 original HUCK Bird's Nests® with connecting
ladders

4 climbing ropes (with climbing aids)

4 climbing chimneys

Various loop ropes and hanging ropes

Ropes and nets made of Hercules rope
(Ø 16 mm, 6-strand, with steel core)

Technical data

Equipment height:	5.10 m
Space requirement:	Ø 4.00 m
Safety zone:	Ø 7.50 m
Min. fall protection:	44.10 m ²
Height of fall:	2.00 m
Ground surface:	see table on page 275

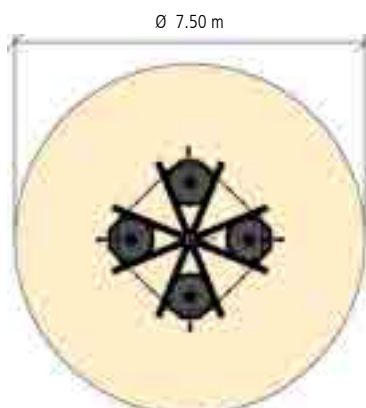





Eagles nest tree

Art.no. 4652-40

Equipment

Steel mast (Ø 194mm), hot-dip galvanised, length 6.20m, with mast
 high-quality, varnished glulam as crossbars
 1 original HUCK birds nest basket (Ø 1.90m)
 2 original HUCK birds nest baskets (Ø 1.00m)
 1 climbing ladder
 1 climbing net
 1 climbing chimney
 2 arch-shaped net passages
 Hercules ropes and nets
 (Ø 16mm, 6 strand, with steel core)

Technical data

Equipment height:	5.75 m
Space requirement:	Ø 4.30 m
Safety zone:	Ø 8.20 m
Min. fall protection:	52.80 m ²
Height of fall:	2.95 m
Ground surface:	see table on page 275

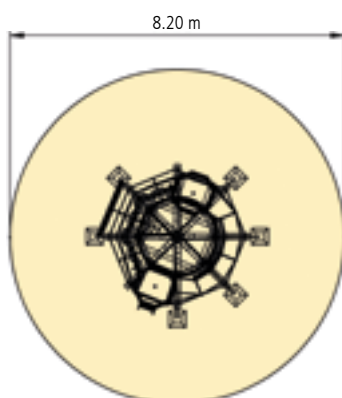





Bird's nest tower

Art.no. 4652-20

Equipment

4 douglas fir posts (Ø 180 mm), with post shoes, length 8.05 m

4 douglas fir crossbeams (Ø 180 mm), length 5.20 m

5 original HUCK Bird's Nests® (Ø 1.20 m)

4 ladder crossings

2 climbing nets

2 rope ladders

1 net chimney

Ropes and nets made of Hercules rope (Ø 16 mm, 6-strand, with steel core)

Technical data

Equipment height: 6.85 m

Space requirement: 7.40 x 6.60 m

Safety zone: 9.95 x 9.80 m

Min. fall protection: 78.50 m²

Height of fall: max. 3.00 m

Ground surface: see table on page 275



Q "Fortuna" bird's nest tower (page 18)

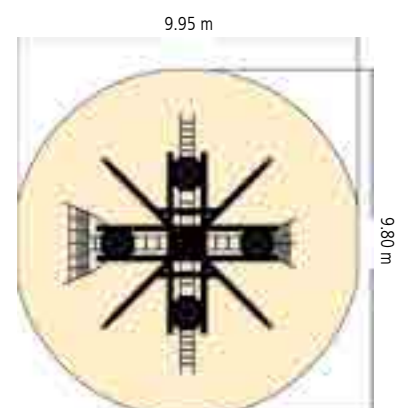





“Black Forest” birds nest tower

Art.no. 4652-21

Equipment

4 douglas fir posts (Ø 180mm), hot-dip, galvanised post shoes, length 7m
4 douglas fir cross beams (Ø 180mm), Length, 5m
2 douglas fir cross beams (Ø 180mm)
1 vertical climbing chimney
1 horizontal crawl tunnel
3 climbing nets
8 climbing ladders
5 climbing ropes
1 climbing wall
1 original HUCK birds nest basket (Ø 1.00m)
1 V-shaped net bridge
1 stainless steel slide
Hercules ropes and nets (Ø 16mm, 6 strand, with steel core)

Technical data

Equipment height:	6.65 m
Space requirement:	7.85 x 5.65 m
Safety zone:	12.00 x 9.90 m
Min. fall protection:	82.20 m ²
Height of fall:	3.00 m
Ground surface:	see table on page 275

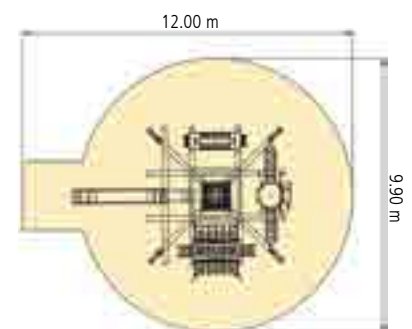



Upon request the crossbeams can also be created in galvanised steel!

Equipment in picture above completely powder-coated

Foto: Wicksteed Playscapes



Pirate tower

Art. no. 4687-20 European design patent

Equipment

- 1 steel mast (Ø 160 mm), hot-dip galvanised, length 6.00 m, special paint (red or blue) available for an additional charge.
- High-quality varnished glulam as cross pieces
- 1 climbing rope
- 2 angled climbing nets
- 2 lounging nets
- 2 horizontal ladders
- 2 horizontal nets
- 4 loop ropes
- 1 lookout platform
- 4 suspension ropes
- Ropes and nets made of Hercules rope (Ø 16 mm, 6-strand, with steel core)

Technical data

Equipment height:	5.30 m
Space requirement:	3.75 x 2.45 m
Safety zone:	7.20 x 7.05 m
Min. fall protection:	45.50 m ²
Height of fall:	2.75 m
Ground surface:	see table on page 275

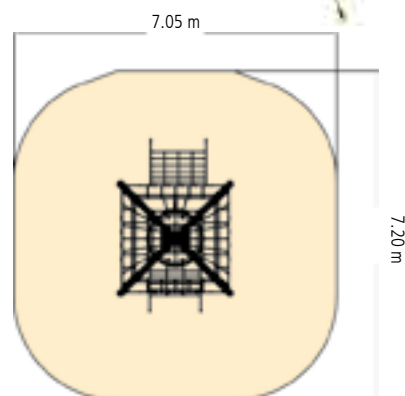

“Fortuna” mini pirate tower (page 15)

Mini pirate tower (page 42)



“Black Beard” pirate ship

Art.no. 4687-25

Equipment

- 1 steel mast (Ø 160mm), hot-dip galvanised, Special paint (red or blue) available for surcharge
- 3 steel posts (Ø 102mm), length 3.50m
- High-quality, lasered glulam as crossbars
- 1 climbing rope
- 5 slanted climbing nets
- 2 guardrail nets
- 1 passage net
- 2 insect nets
- 2 climbing ladders
- 2 horizontal ladders
- 2 horizontal nets
- 4 garland ropes
- 1 viewing platform
- 4 retaining ropes
- 1 GRP slide
- Hercules ropes and nets (Ø 16mm, 6 strand, with steel core)

Technical data

Equipment height:	5.00 m
Space requirement:	11.45 x 3.75 m
Safety zone:	14.95 x 7.20 m
Min. fall protection:	71.00 m ²
Height of fall:	2.75 m
Ground surface:	see table on page 275

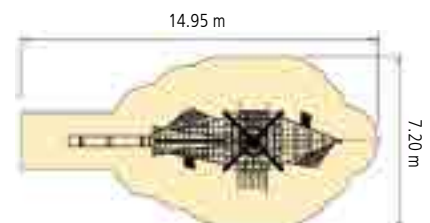



Maxi climbing teepee

Art.no. 4587-23

Equipment
4 steel posts (Ø 102 mm), length 6.00 m, hot-dip galvanised, special paint (blue) included in delivery
1 top plate
2 horizontal net bases
1 slackmaster balancing element
8 rope ladders
1 climbing chimney
Ropes and nets made of Hercules rope (Ø 16 mm, 6-strand, with steel core)

Technical data
Equipment height: 4.50 m
Space requirement: 4.10 x 4.10 m
Safety zone: 6.60 x 6.60 m
Min. fall protection: 41.40 m ²
Height of fall: 3.00 m
Ground surface: see table on page 275



Q Midi climbing wigwam (page 57)

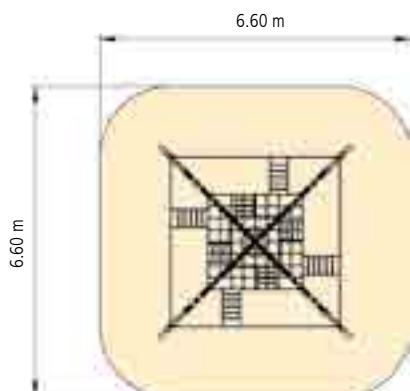



Hourglass

Art. no. 4592 European design patent

Equipment

1 steel mast (Ø 160 mm), hot-dip galvanised, length 6.00 m, special colour (red or blue) available for an additional charge

2 rope ladders

2 climbing ropes with climbing aids

2 funnel-shaped climbing nets

2 horizontal nets inside the rings

Ropes and nets made of Hercules rope (Ø 16 mm, 6-strand, with steel core)

Technical data

Equipment height: 5.30 m

Space requirement: Ø 3.00 m

Safety zone: Ø 7.00 m

Min. fall protection: 39.00 m²

Height of fall: max. 3.00 m

Ground surface: see table on page 275



Q Mini hourglass (spinning equipment)
(page 59)

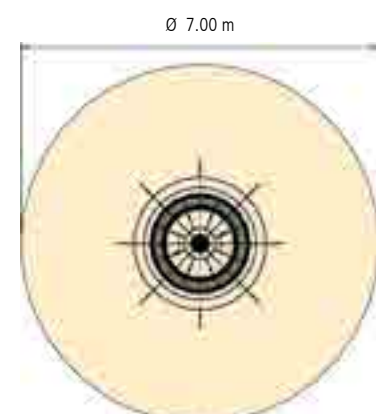



Spinning mushroom

Art.no. 4530-60

Equipment

1 steel mast (Ø 160 mm), hot-dip galvanised, length 3.00 m, with caps special paint (red) included in delivery

Rope ladder rungs made of PA

Triangle rope ladders made of Hercules rope (Ø 16 mm, 6-strand, with steel core)

Technical data

Equipment height: 2.45 m

Space requirement: Ø 2.00 m

Safety zone: Ø 8.00 m

Min. fall protection: 50.50 m²

Height of fall: 1.60 m

Ground surface: see table on page 275

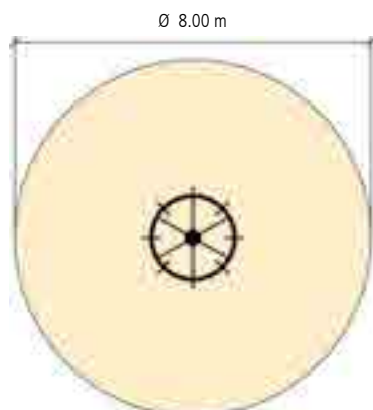

Rope course – fantastic variety

HUCK rope courses are combined from numerous separate elements to create one individual play world. Rubber mats, hanging ropes, wobble beams, climbing nets, clambering loops and rings, bars and many other elements can be suspended between posts that are up to 3 m high. Various bridge constructions and climbing games are also part of the fun. The course can be set up as a curve, triangle, square or polygon – whatever you choose, children over the age of 3 will have a lot of space for their play fun and at the same time train their fine motor skills. Robinia wood posts provide a natural-looking alternative to painted steel posts.

| 88 |



Sports day assault course

| 92 |



Fun play course 2010

| 96 |



Vario system

| 100 |



Adventure course



Play course with robinia posts

HUCK play courses are individually combined from rope and climbing elements and are therefore optimally adapted to suit all age groups and requirements.

Robinia wood posts are new in the HUCK range. They look very natural due to the twisted growth of the wood. This natural product provides the play course with an elemental, natural touch.

Our robinia posts have bevelled ends. Robinia is particularly splinter-free and has can also be inserted into the ground without needing any chemical treatment.

The HUCK posts come with steel safety plates that will ensure stability for years to come. The robinia woods come with a 5-year guarantee.

Net and rope elements made from heavy duty Hercules rope can be combined into individual complete play courses of varying sizes.

The individual elements can be fixed to the naturally grown posts in any position with the help of special fittings with adjustable chains.



Safe fittings

Sufficiently strong chains together with large stainless steel plates securely combine the individual play elements. The chains are fed through drill holes in the robinia posts.

The buried stainless steel round plates optimally distribute the power from the chain to the wood.

Assembly is very simple:
Feed the tension chain with shackle through the drill hole, tension the chain and screw it tight with a split washer, cut off excess chain – done. The fixing components for robinia posts can be found on page 241.



Robinia posts are delivered without drill holes. You can obtain the required equipment at a competitive price on request.

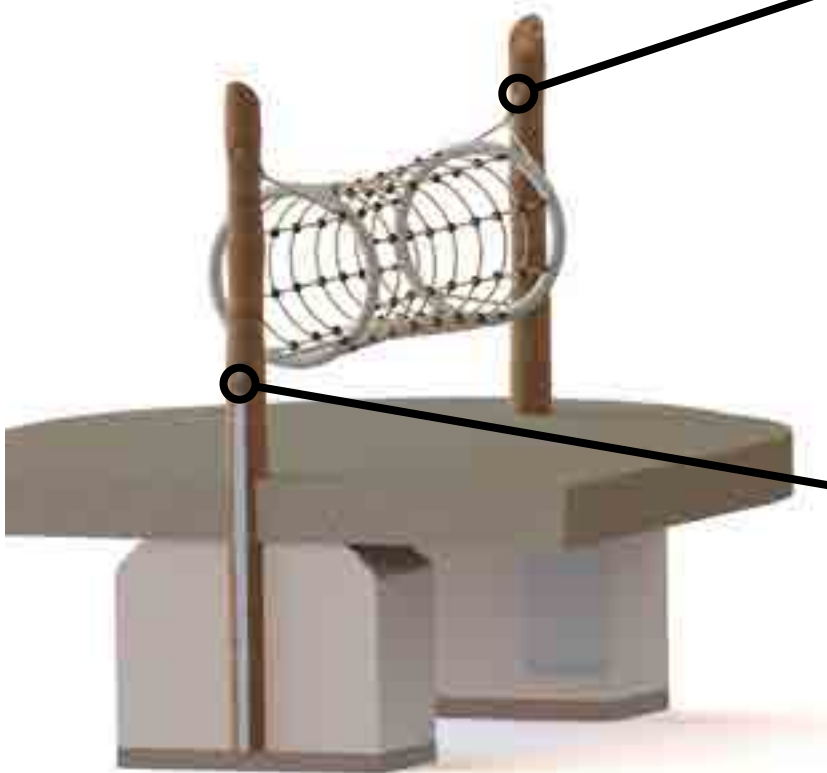

All robinia posts have an additional safety steel plate.

Special models

HUCK special models provide even more individuality and fun when playing:

The robinia posts can be expanded with large climbing grooves and wooden platforms.



Groover per cut

Art. n. 4575-K
(required height has to be stated in advance)

Platform

Art. n. 4575-S (size approx. 450 x 450 mm)
(required height has to be stated in advance, max. height 1.00 m)



Sports day assault course

Equipment

Standard version: Steel posts (Ø 102 mm), hot-dip galvanised, length 2.00 m, with caps, special paint (red) included in delivery

Ropes and nets made of Hercules rope (Ø 16 mm, 6-strand, with steel core)

Technical data

Equipment height: 1.30 m (steel posts)
1.50 m (robinia posts)

Space requirement: depending on element(s) used

Safety zone: depending on element(s) used

Min. fall protection: depending on element(s) used

Height of fall: max. 1.20 m

Ground surface: see table on page 275

Caution!

The space required for the equipment foundation (assembly space) is larger than the safety zone.



The grid dimension is always 3.00 m.

The technical data is given as an example in each case for a single piece of equipment. The equipment height, height of fall and ground surface required are the same. The space requirement and safety zone or min. fall protection vary depending on the set-up or type of equipment.

Clips are included in delivery for individual elements without posts.

All rope course elements can be freely combined with each other (see photo).

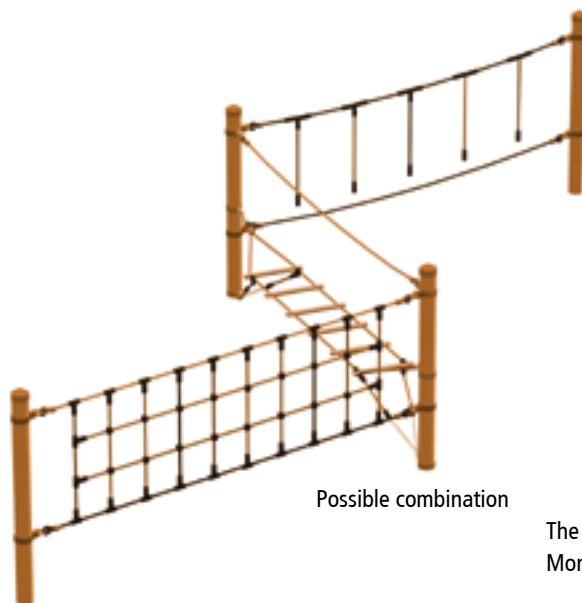

Possible combination



The sports day assault course is now also available with robinia posts. More information can be found on page 85.

Steel posts separate

Art.no. 4591-0

Equipment

Steel posts (Ø 102 mm), hot-dip galvanised, length 2.00 m, with caps, special paint (red) included in delivery

Robinia posts separate

Art.no. 4591-0-R

Equipment

Robinia posts (Ø 160 - 200 mm), length 2.20 m + bevel, without drill holes for attachments, incl. steel plates

Sports day assault course, individual elements (excluding posts)



Swing seats

Art. no. 4591-1 for steel posts

Art. no. 4591-1-R for robinia posts, with chain and PA discs



Rope ladder

Art. no. 4591-2 for steel posts

Art. no. 4591-2-R for robinia posts, with chain and PA discs

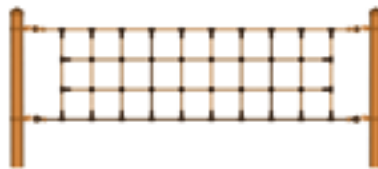

Climbing net

Art. no. 4591-3 for steel posts

Art. no. 4591-3-R for robinia posts, with chain and PA discs



Balancing rope

Art. no. 4591-4 for steel posts

Art. no. 4591-4-R for robinia posts, with chain and PA discs



Rubber hammock

Art. no. 4591-5 for steel posts

Art. no. 4591-5-R for robinia posts, with chain and PA discs



Rope ladder rungs

Art. no. 4591-6 for steel posts

Art. no. 4591-6-R for robinia posts, with chain and PA discs

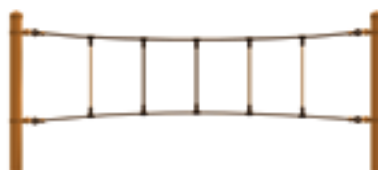

Slackline

Art. no. 4591-7 for steel posts

Art. no. 4591-7-R for robinia posts, with chain and PA discs



Hanging rope

Art. no. 4591-8 for steel posts

Art. no. 4591-8-R for robinia posts, with chain and PA discs



Wobble beam

Art. no. 4591-9 for steel posts
 Art. no. 4591-9-R for robinia posts, with chain and PA discs



Tyres

Art. no. 4591-10 for steel posts
 Art. no. 4591-10-R for robinia posts, with chain and PA discs



Polyester hammock

Art. no. 4591-11 for steel posts
 Art. no. 4591-11-R for robinia posts, with chain and PA discs

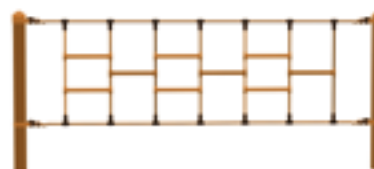

Climbing rungs

Art. no. 4591-12 for steel posts
 Art. no. 4591-12-R for robinia posts, with chain and PA discs



Holding rings

Art. no. 4591-13 for steel posts
 Art. no. 4591-13-R for robinia posts, with chain and PA discs



Holding loops

Art. no. 4591-14 for steel posts
 Art. no. 4591-14-R for robinia posts, with chain and PA discs

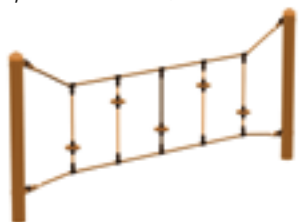

Small disks

Art. no. 4960-3 for steel posts
 Art. no. 4960-3-R for robinia posts, with chain and PA discs



Bar separate

Art. no. 4960-9 for steel posts

**NEW**

Goal and climbing wall

Art. no. 4591-18 for steel posts

Art. no. 4591-18-R for robinia posts, with chain and PA discs

**NEW**

Labyrinth Ball

Art. no. 4591-16 for steel posts

Art. no. 4591-16-R for robinia posts, with chain and PA discs

**NEW**

1000 balls

Art. no. 4591-17 for steel posts

Art. no. 4591-17-R for robinia posts, with chain and PA discs

**NEW**

Surfer

Art. no. 4591-15 for steel posts

Art. no. 4591-15-R for robinia posts, with chain and PA discs





Fun play course 2010

Equipment

Standard version: Steel posts (Ø 102 mm), hot-dip galvanised, length 2.40 m, with caps, special paint (blue) included in delivery

Ropes and nets made of Hercules rope (Ø 16 mm, 6-strand, with steel core)

Technical data

Equipment height: 1.70 m (steel posts)
1.90 m (robinia posts)

Space requirement: depending on element(s) used

Safety zone: depending on element(s) used

Min. fall protection: depending on element(s) used

Height of fall: max. 1.50 m

Ground surface: see table on page 275

The grid dimension is always 3.00 m.

The space requirement and safety zone or min. fall protection vary depending on the set-up or type of equipment.

Clips are included in delivery for individual elements without posts.

All rope course elements can be freely combined with each other (see photo).

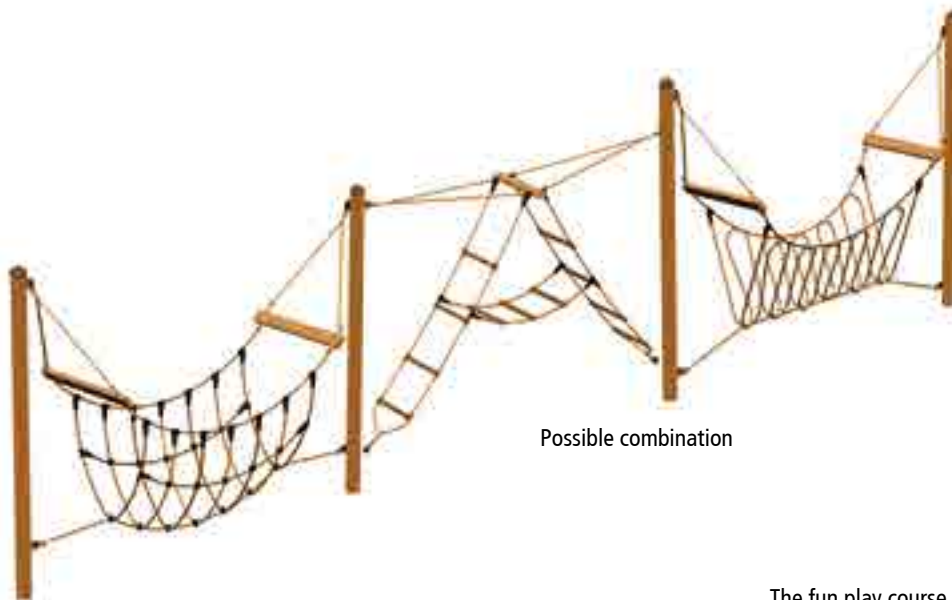

Possible combination



The fun play course 2010 is now also available with robinia posts. More information can be found on page 85.

Steel posts separate

Art.no. 4960-0

Equipment

Steel posts (Ø 102 mm), hot-dip galvanised, length 2.40 m, with caps, special paint (blue) included in delivery

Robinia posts separate

Art.no. 4960-0-R

Equipment

Robinia posts (Ø 160 – 200 mm), length 2.80 m + bevel, without drill holes for attachments, incl. steel plates

Fun play course 2010, individual elements (excluding posts)

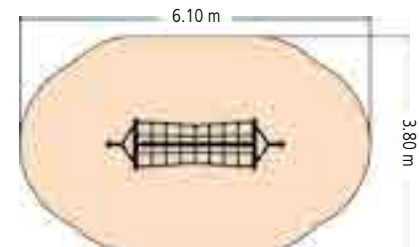

Climbing play - adventure tunnel

Art. no. 4960-1 for steel posts

Art. no. 4960-1-R for robinia posts, with chain and PA discs

Equipment

1 net tunnel with 2 steel rings wound round with rope (Ø 80 cm), 4 suspension ropes, total length 3.00 m (dimension between centre lines of posts)

Ropes and nets made of Hercules rope (Ø 16 mm, 6-strand, with steel core)

Technical data

Equipment height: 1.70 m

Space requirement: 3.10 x 0.80 m

Safety zone: 6.10 x 3.80 m

Min. fall protection: 19.50 m²

Height of fall: 1.25 m

Ground surface: see table on page 275

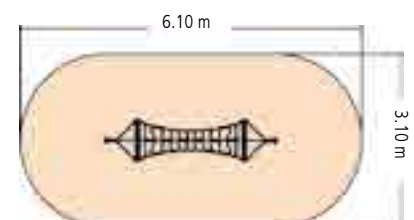

Climbing play - loop bridge

Art. no. 4960-2 for steel posts

Art. no. 4960-2-R for robinia posts, with chain and PA discs

Equipment

1 net bridge, length 3.00 m (dimension between centre lines of posts)

Ropes and nets made of Hercules rope (Ø 16 mm, 6-strand, with steel core)

Technical data

Equipment height: 1.70 m

Space requirement: 3.10 x 0.80 m

Safety zone: 6.10 x 3.10 m

Min. fall protection: 17.00 m²

Height of fall: 0.40 m

Ground surface: see table on page 275



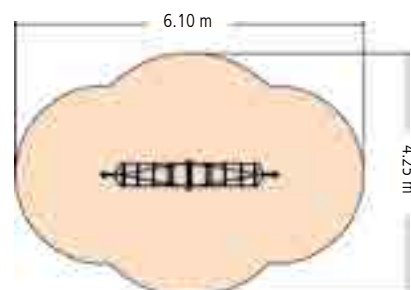

Climbing play - 3-part ladder

Art. no. 4960-4 for steel posts

Art. no. 4960-4-R for robinia posts, with chain and PA discs

Equipment

2 angled ladders, 1 horizontal ladder with plastic rungs

2 suspended trapezes, total length 3.00 m (dimension between centre lines of posts)

Ropes and nets made of Hercules rope (Ø 16 mm, 6-strand, with steel core)

Technical data

Equipment height: 1.70 m

Space requirement: 3.10 x 0.55 m

Safety zone: 6.10 x 4.25 m

Min. fall protection: 19.00 m²

Height of fall: max. 1.50 m

Ground surface: see table on page 275

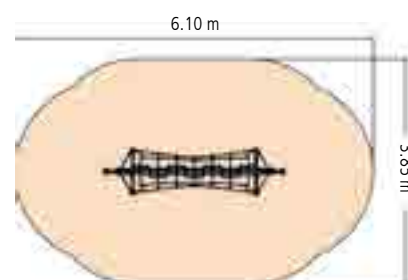

Climbing play - arch bridge

Art. no. 4960-5 for steel posts

Art. no. 4960-5-R for robinia posts, with chain and PA discs

Equipment

1 net bridge, length 3.00 m (dimension between centre lines of posts)

Ropes and nets made of Hercules rope (Ø 16 mm, 6-strand, with steel core)

Technical data

Equipment height: 1.70 m

Space requirement: 3.10 x 0.80 m

Safety zone: 6.10 x 3.85 m

Min. fall protection: 19.50 m²

Height of fall: 1.40 m

Ground surface: see table on page 275



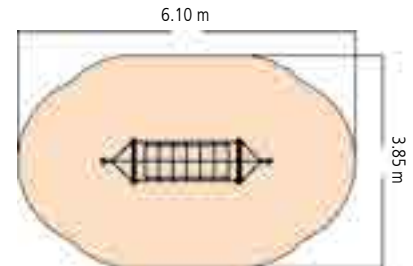

Climbing play - bridge

Art. no. 4960-6 for steel posts

Art. no. 4960-6-R for robinia posts, with chain and PA discs

Equipment

1 net bridge, length 3.00 m (dimension between centre lines of posts)

Ropes and nets made of Hercules rope (Ø 16 mm, 6-strand, with steel core)

Technical data

Equipment height: 1.70 m

Space requirement: 3.10 x 0.80 m

Safety zone: 6.10 x 3.85 m

Min. fall protection: 19.50 m²

Height of fall: 1.25 m

Ground surface: see table on page 275

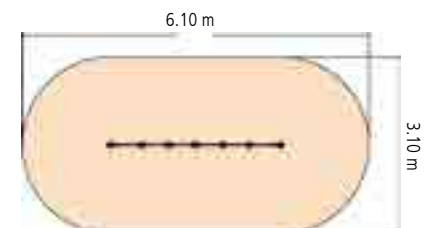

Climbing play - small disks

Art. no. 4960-7 for steel posts

Art. no. 4960-7-R for robinia posts, with chain and PA discs

Equipment

1 balancing and holding element with plastic disks

1 horizontal ladder with plastic rungs, total length 3.00 m (dimension between centre lines of posts)

Ropes and nets made of Hercules rope (Ø 16 mm, 6-strand, with steel core)

Technical data

Equipment height: 1.70 m

Space requirement: 3.10 x 0.10 m

Safety zone: 6.10 x 3.10 m

Min. fall protection: 17.00 m²

Height of fall: 1.25 m

Ground surface: see table on page 275





Vario system

Equipment

Standard version: Steel posts (Ø 102 mm), hot-dip galvanised, length 3.00 m, with caps, special paint (red) included in delivery

Ropes and nets made of Hercules rope (Ø 16 mm, 6-strand, with steel core)

Technical data

Equipment height:	2,20 m (steel posts) 2,40 m (robinia posts)
Space requirement:	depending on element(s) used
Safety zone:	depending on element(s) used
Min. fall protection:	depending on element(s) used
Height of fall:	1,50 m max. 2,10 m (Element 8)
Ground surface:	see table on page 275



The grid dimension is always 2.25 m.

Easy to maintain, easy to install and with numerous different combination options – that is what sets the HUCK Vario systems apart. Create your own Vario system to suit your own individual space. Prices exclude posts because each set-up requires a different number of posts. Nets made of Hercules rope are of proven HUCK quality.

Clips are included in delivery for individual elements without posts (no drilling required).

All rope course elements can be freely combined with each other (see photo).

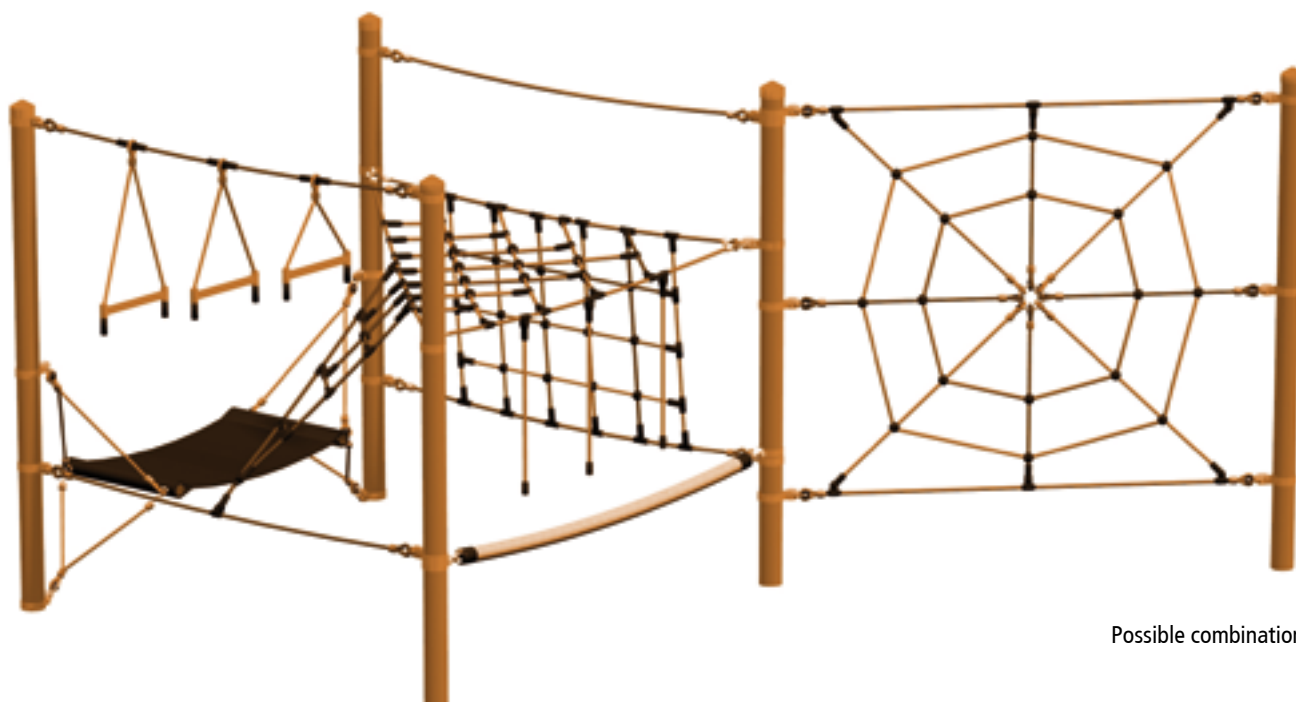

Possible combination

Vario system, individual elements (excluding posts)



The vario system is now also available with robinia posts.
More information can be found on page 85.

Steel posts separate

Art.no. 4591-30-0

Equipment

Steel posts (Ø 102 mm), hot-dip galvanised, length 3.00 m, with caps, special paint (red) included in delivery

Robinia posts separate

Art.no. 4591-30-0-R

Equipment

Robinia posts (Ø 160 – 200 mm), length 3.30 m + bevel, without drill holes for attachments, incl. steel plates



Vario element 1

Art.no. 4591-30-1 for steel posts

Art.no. 4591-30-1-R for robinia posts, with chain and PA discs



Vario element 2

Art.no. 4591-30-2 for steel posts

Art.no. 4591-30-2-R for robinia posts, with chain and PA discs



Vario element 3

Art.no. 4591-30-3 for steel posts

Art.no. 4591-30-3-R for robinia posts, with chain and PA discs



Vario element 4

Art.no. 4591-30-4 for steel posts

Art.no. 4591-30-4-R for robinia posts, with chain and PA discs



Vario element 5

Art.no. 4591-30-5 for steel posts

Art.no. 4591-30-5-R for robinia posts, with chain and PA discs

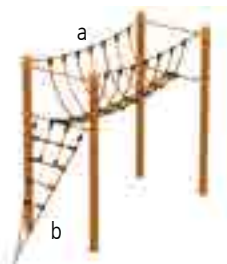

Vario element 6 + 7

- a) Art.no. 4591-30-6 for steel posts
 Art.no. 4591-30-6-R for robinia posts, with chain and PA discs
 b) Art.no. 4591-30-7 for steel posts
 Art.no. 4591-30-7-R for robinia posts, with chain and PA discs



Vario element 8

- Art.no. 4591-30-8 for steel posts
 Art.no. 4591-30-8-R for robinia posts, with chain and PA discs



Vario element 9

- Art.no. 4591-30-9 for steel posts
 Art.no. 4591-30-9-R for robinia posts, with chain and PA discs

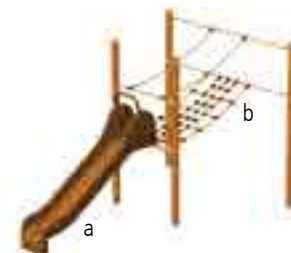

Vario element 10 + 11

- a) Art.no. 4591-30-10 slide for steel posts
 Art.no. 4591-30-10-R for robinia posts, with chain and PA discs
 b) Art.no. 4591-30-11 slide for steel posts
 Art.no. 4591-30-11-R for robinia posts, with chain and PA discs



Vario element 12

- Art.no. 4591-30-12 for steel posts
 Art.no. 4591-30-12-R for robinia posts, with chain and PA discs



Vario element 13

- Art.no. 4591-30-13 for steel posts
 Art.no. 4591-30-13-R for robinia posts, with chain and PA discs



Vario element 14

- Art.no. 4591-30-14 for steel posts
 Art.no. 4591-30-14-R for robinia posts, with chain and PA discs



Vario element 15

- Art.no. 4591-30-15 for steel posts
 Art.no. 4591-30-15-R for robinia posts, with chain and PA discs



Vario element 16

- Art.no. 4591-30-16 for steel posts
 Art.no. 4591-30-16-R für Robinia posts, mit Kette und VA-Scheiben



Vario element 17

- Art.no. 4591-30-17 for steel posts
 Art.no. 4591-30-17-R for robinia posts, with chain and PA discs

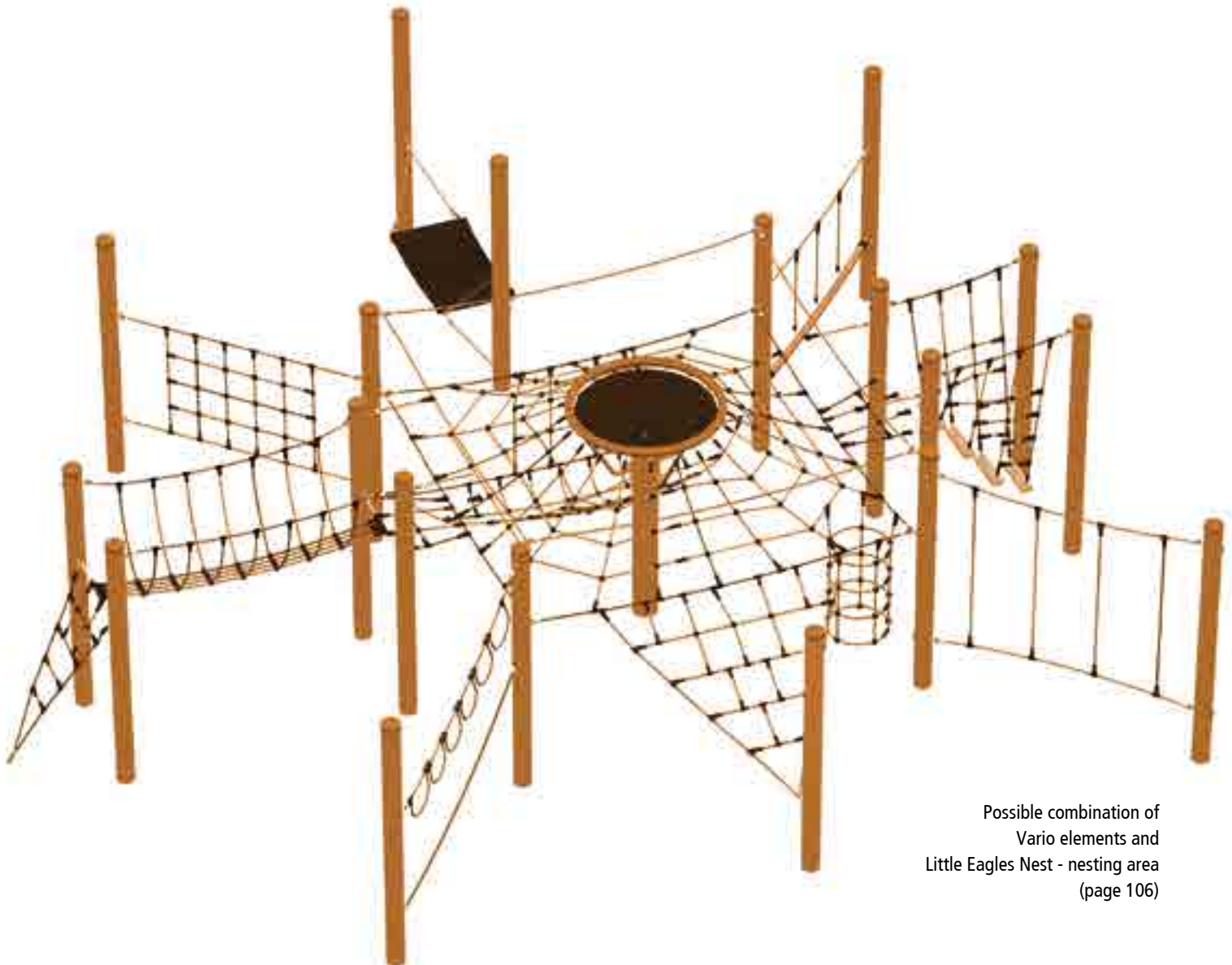

Possible combination of
Vario elements and
Little Eagles Nest - nesting area
(page 106)



Vario element 19

Art. no. 4591-30-19 for steel posts

Art. no. 4591-30-19-R for robinia posts, with chain and PA discs



Vario element 20

Art. no. 4591-30-20 for steel posts

Art. no. 4591-30-20-R for robinia posts, with chain and PA discs

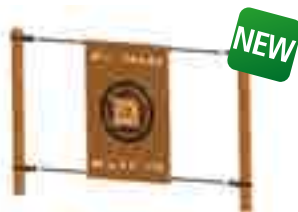

Vario element 21

Art. no. 4591-30-21 for steel posts

Art. no. 4591-30-21-R for robinia posts, with chain and PA discs

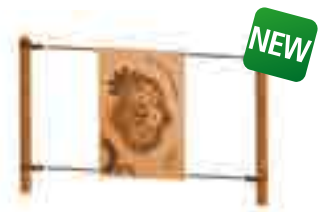

Vario element 22

Art. no. 4591-30-22 for steel posts

Art. no. 4591-30-22-R for robinia posts, with chain and PA discs



Adventure course

Equipment

Standard version: Steel posts (Ø 102 mm), hot-dip galvanised, length 3.00 m, with caps, special paint (red) included in delivery

Plastic platform (HDPE) (Ø 500 mm)

Ropes made from Hercules rope (Ø 16 mm, 6-strand, with steel core)

Technical data

Equipment height: 2.20 m (steel posts)
2.40 m (robinia posts)

Space requirement: depending on element(s) used

Safety zone: depending on element(s) used

Min. fall protection: depending on element(s) used

Height of fall: 1.50 m

Ground surface: see table on page 275



The grid dimension is always 3.00 m.

Combine climbing course elements to suit your individual requirements

All HUCK climbing course elements (even elements from different series) can be combined. Let us know your desired combination and we will advise you on how to realise it.

Solutions for limited space

Where space is limited, the play system opposite can also be installed in a square with just four corner posts. In this case, the space requirement and safety zone are only 3.10 x 3.10 m and 6.10 x 6.10 m respectively.

Create your own rope course

With HUCK's adventure course, nothing could be easier. You can combine the elements in whatever order you want – simply adapt them to local conditions. In the example, we have combined four standard elements. All elements can be adjusted to any height. This increases the number of possible combinations, making every adventure course unique.

Clips are included in delivery for individual elements without posts.

All rope course elements can be freely combined with each other (see photo).

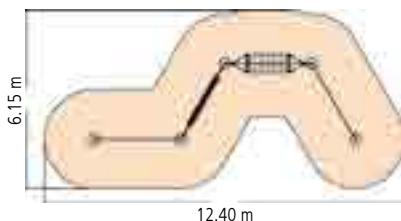

Adventure course, individual elements (excluding posts)

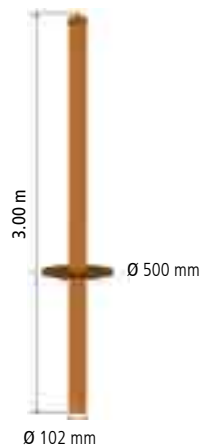

Steel posts including platform (HDPE), separate

Art.no. 4591-60-0

Equipment

Steel posts (Ø 102 mm), hot-dip galvanised, length 3.00 m, with caps, special paint (red) included in delivery

Plastic platform (HDPE) (Ø 500 mm)



The adventure course is now also available with robinia posts. More information can be found on page 85.

Robinia posts separate

Art.no. 4591-60-0-R

Equipment

Robinia posts (Ø 160 – 200 mm), length 3.30 m + bevel, without platform (see page 83), without drill holes for attachments, incl. steel plates



Rubber hammock

Art.no. 4591-60-5 for steel posts

Art.no. 4591-60-5-R for robinia posts, with chain and PA discs

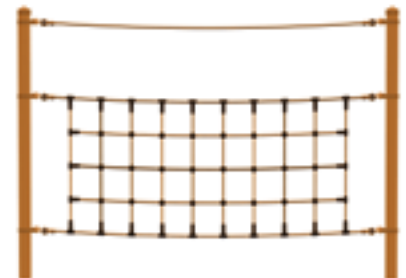

Climbing net

Art.no. 4591-60-3 for steel posts

Art.no. 4591-60-3-R for robinia posts, with chain and PA discs



Hanging rope

Art.no. 4591-60-8 for steel posts

Art.no. 4591-60-8-R for robinia posts, with chain and PA discs



Wobble beam

Art.no. 4591-60-9 for steel posts

Art.no. 4591-60-9-R for robinia posts, with chain and PA discs



Team seesaw

Team buildings course

In addition to our known rope play course in different designs on these pages we present what we call lower rope courses as team or team-building courses.

These have been designed and developed by Joachim Rätz (mediation, consultancy and seminars in Herrenberg in order to reach young people (teens) and groups (teams). A learning field is offered with the course in which users can acquire traits, which lead to knowledge and insight.

The course elements can be laid out in a multitude of ways and contain equipment such as:

- ✔ Team seesaw
- ✔ Team platform
- ✔ Balancing way
- ✔ Zig zag way
- ✔ "Chaplins Walk"
- ✔ Wobble beam bridge
- ✔ Tightrope bridge
- ✔ Diverging V
- ✔ "Chicken in the coop"
- ✔ Labyrinth
- ✔ Spiders web

which as a so-called interaction course suited for the area of use (e.g. parks or school playgrounds) can be deliberately set out in a certain sequence for team building and strategy development.

The materials used include posts and basic elements made from wood as well as diverse HUCK rope and net materials.

Find out more information and see what interesting options the team or lower rope courses can offer your land.

www.seilwelten.de/home/team/parcours

unerspielplatz.de.rs
 Joachim Rätz / Herrenberg
 Tel.: +49 0171 7210330
 JoachimRaetz@t-online.de



Diverging V



Spinning net



Balancing log



Tightrope bridge



Zigzag path



Chaplins walk

Eagle series – a fantastic outlook

In the eagle series, children are enthroned like an actual bird's nest on a high post. Safeguarded by climbing nets, they can enjoy the view from up high, looking over the entire playground. At the core of the eagle's nest series is the original HUCK Bird's Nest®, a round close-meshed basket with a base shaped to form a nest and a steel ring wound round with rope. The original HUCK Bird's Nests® are available in various colours. Various ascent and descent options, such as slides, ropes and ladders, provide exciting climbing alternatives and ensure plenty of adventure.

| 104 |



Little Eagles nest - prairie

| 105 |



"Eagles Lair" Eagles nest

| 106 |

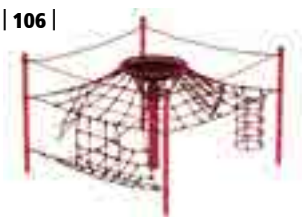

Little Eagles Nest - nesting area

| 107 |



Little Eagles nest



Little Eagles nest - prairie

Art. no. 4 63 4 - 1 0 Douglas fir/oak posts (Ø 200/160 mm)

Art. no. 4 63 4 - 1 0 PS Pure Douglas fir posts (Ø 200/180 mm)

Slide also available in stainless steel for a surcharge!
(page 279)

Equipment

- Standard version: 1 Douglas fir centre post (Ø 200 mm), with post shoe, 4 oak posts (Ø 160 mm), varnished, in various lengths, with steel safety plate

- 1 vertical net climber

- 1 horizontal net

- 1 rope ladder

- 1 climbing net

- 1 GRP slide

- 1 rubber climber

- 1 V-bridge

- 1 original HUCK Bird's Nest® (Ø 1.90)

- Ropes and nets made of Hercules rope (Ø 16 mm, 6-strand, with steel core)

Technical data

Equipment height:	3.80 m
Space requirement:	4.80 x 11.10 m
Safety zone:	7.80 x 14.60 m
Min. fall protection:	68.00 m ²
Height of fall:	2.00 m
Ground surface:	see table on page 275

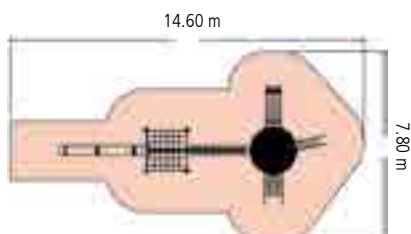



“Eagles Lair” Eagles nest

Art.no. 4634-20

Equipment

Standard version: 4 Robinia posts (Ø 210 -250mm), without drill holes, Length 4.00m with safety steel plates

1 trapeze net with chain fastening and post connecting part

1 triangular hammock with chain fastening and post connector

1 K2 climbing wall, 2.70 x 2.00 m, suspended On free-hanging chains

Hercules ropes and nets (Ø 16 mm, 6-strand, with steel core)

Technical data

Equipment height: 3.20 m

Space requirement: 6.25 x 3.00 m

Safety zone: 10.15 x 6.80 m

Min. fall protection: 49.70 m²

Height of fall.: 2.80 m

Ground surface: see table on page 275



The special wall which can be climbed on both sides is the suspended type. It is suspended on 6 chains and swings within a defined motion. Sitting on the wall each conqueror is rewarded with the view from the summit! The ability to climb over it means that the entire climbing wall can be used and can thus be climbed by many children at the same time. The wooden edge is even protected with special rubber.

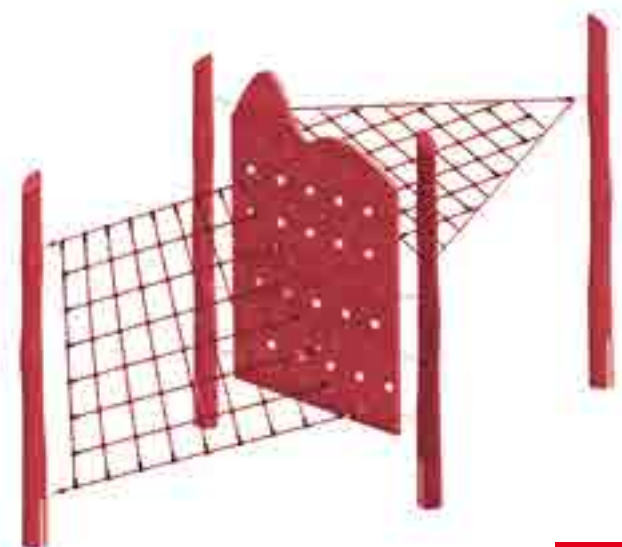
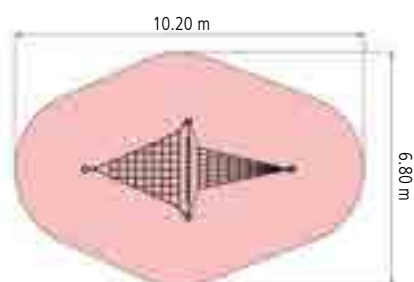



Little Eagles Nest - nesting area

Art.no. 4634-70

Equipment

1 steel centre post (Ø 193 mm), hot-dip galva-
nised, length 2.50 m, 4 steel posts (Ø 102 mm),
hot-dip galvanised, length 3.00 m

1 original HUCK Bird's Nest® (Ø 1.20)

1 conical net

1 vertical climbing net

1 triangle hanging net

1 rope ladder

1 triangle climbing net

1 climbing tunnel

4 rope handrails

Ropes and nets made of Hercules rope
(Ø 16 mm, 6-strand, with steel core)

Technical data

Equipment height: 2.20 m

Space requirement: 4.10 x 4.65 m

Safety zone: 7.10 x 7.65 m

Min. fall protection: 43.50 m²

Height of fall: 1.40 m

Ground surface: see table on page 275

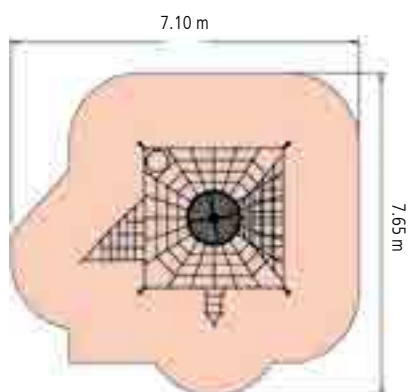



Little Eagles nest

- Art. no. 4634 with slide (GRP), oak posts (Ø 200 mm), with steel safety plates
 Art. no. 4634S with slide (GRP), steel posts (Ø 193 mm)
 Art. no. 4634-1 without slide, oak posts (Ø 200 mm), with steel safety plates
 Art. no. 4634-1S without slide, steel posts (Ø 193 mm)

Slide also available in stainless steel for a surcharge! (page 279)

GRP slide available in red or green.

Equipment

Standard version: Oak posts (Ø 200 mm), varnished, length 1.40 m, with steel safety plates
 1 rope ladder
 1 trapeze climbing net
 1 original HUCK Bird's Nest® (Ø 1.20)
 Ropes and nets made of Hercules rope (Ø 16 mm, 6-strand, with steel core)

Technical data without slide

Equipment height:	1.00 m
Space requirement:	1.90 x 2.55 m
Safety zone:	4.55 x 4.85 m
Min. fall protection:	17.30 m
Height of fall:	1.00 m
Ground surface:	see table on page 275



Technical data with slide

Equipment height:	1.70 m
Space requirement:	3.70 x 2.55 m
Safety zone:	6.95 x 4.85 m
Min. fall protection:	24.00 m ²
Height of fall:	1.00 m
Ground surface:	see table on page 275

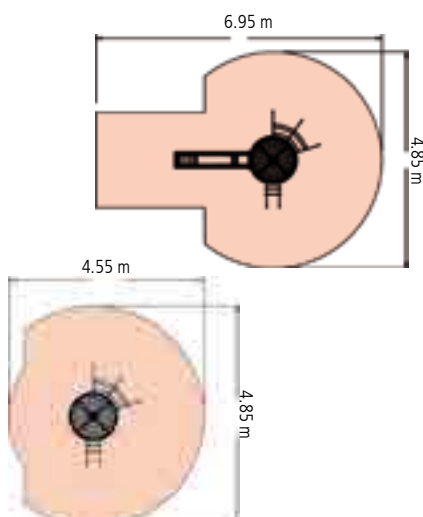

Rope net pyramids – an exciting adventure

HUCK pyramids make the most of the benefits of rope play equipment: the taut net surfaces act as a play element but also as fall protection, enabling children to climb much higher. Just like in real life, HUCK pyramids also have inner elements, for example rope ladders, levels and net chimneys. Colourful square and rectangular meshes made of HUCK's tried-and-tested Hercules rope give the climbing nets their stability and make for an exciting climbing adventure in the world of the pharaohs. All HUCK pyramids are available in mini, midi and maxi versions depending on the target age group and desired degree of difficulty. Ideal for little explorers looking for adventure!

| 111 |

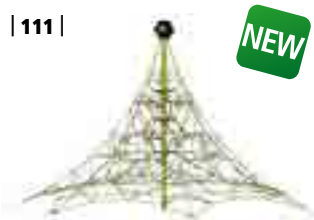

SPIDER series

| 119 |

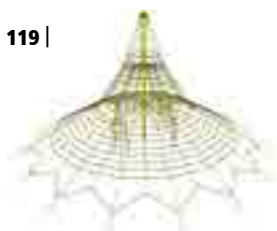

Cheops Series

| 128 |

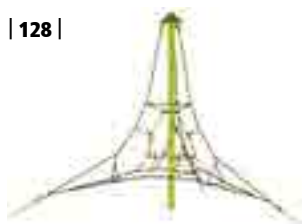

TRIOPS pyramid series

| 130 |

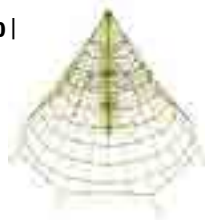

Rope net tower series

| 133 |



Dino series

| 138 |



Super-climb series







Standard colour combination black-red with aluminium connectors.

Upon request in black with orange powder-coated aluminium connectors and SPIDER sign for the post ends.



SPIDER 4 rope pyramid with 4 guy lines

Art.no. 5000-4-4

Equipment

1 steel post (Ø 159mm), hot-dip galvanised, with aluminium cap
 3D climbing net structure
 4 M16 turnbuckles, galvanised
 Hercules rope ropes and nets
 (Ø 18mm, 6-strand with steel core)

Technical data

Equipment height:	4.30 m
Space requirement:	5.70 x 5.70 m
Safety zone:	7.80 x 7.80 m
Min. fall protection:	53.00 m ²
Height of fall:	0.85 m
Ground surface:	see table on page 275 Grass, as pictured is not permissible!

Attention!

The space required for the foundations is bigger than the minimum space for the equipment.

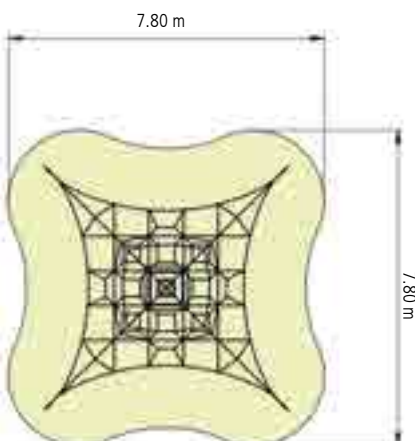





SPIDER 6 rope pyramid with 4 guy lines

Art.no. 5000-6-4

Equipment

1 steel post (Ø 193mm), hot-dip galvanised, with aluminium cap
 3D climbing net structure
 4 M16 turnbuckles, galvanised
 Hercules rope ropes and nets (Ø18 mm, 6-strand with steel core)

Technical data

Equipment height: 6.20 m
 Space requirement: 8.75 x 8.75 m
 Safety zone: 11.00 x 11.00 m
 Min. fall protection: 103.00 m²
 Height of fall: 1.80 m
 Ground surface: see table on page 275

Attention!

The space required for the foundations is bigger than the minimum space for the equipment.

Standard colour combination black-red with aluminium connectors.

Upon request in black with orange powder-coated aluminium connectors and SPIDER sign for the post ends.

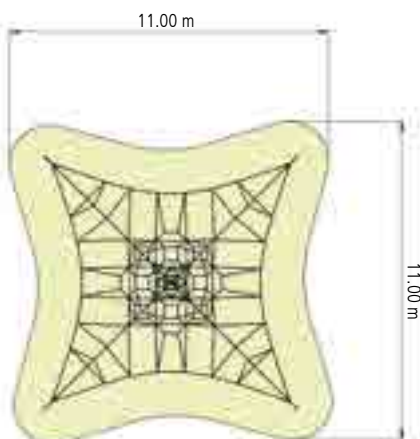

We reserve the right to make technical alterations.





Standard colour combination black-red with aluminium connectors.

Upon request in black with orange powder-coated aluminium connectors and SPIDER sign for the post ends.



SPIDER 6 rope pyramid with 6 guy lines

Art.no. 5000-6-6

Equipment

- 1 steel post (Ø 193mm), hot-dip galvanised, with aluminium cap
- 3D climbing net structure
- 4 M16 turnbuckles, galvanised
- Hercules rope ropes and nets (Ø 18mm, 6-strand with steel core)

Technical data

Equipment height:	6.00 m
Space requirement:	11.30 x 9.80 m
Safety zone:	14.60 x 13.00 m
Min. fall protection:	125.00 m ²
Height of fall:	1.60 m
Ground surface:	see table on page 275

Attention!

The space required for the foundations is bigger than the minimum space for the equipment.

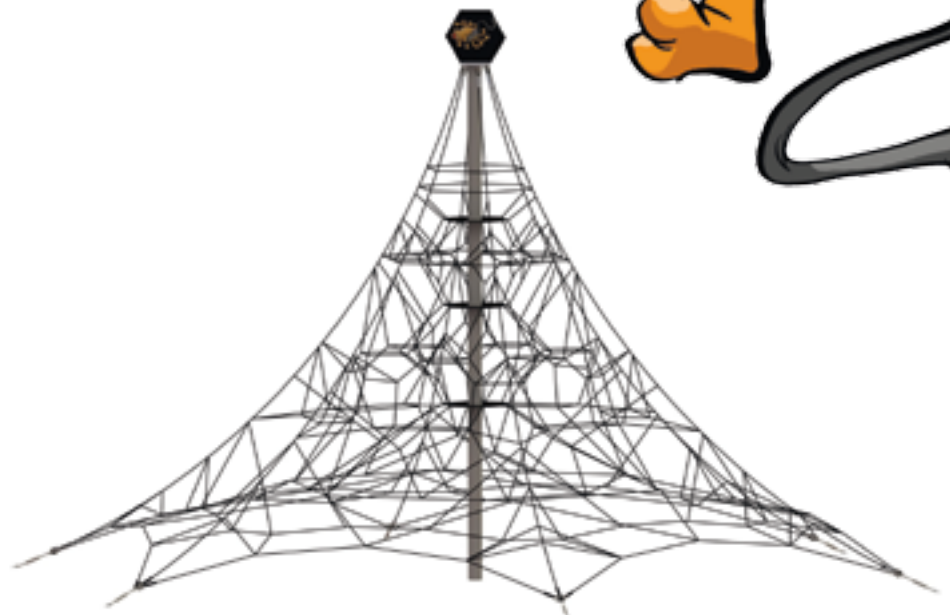
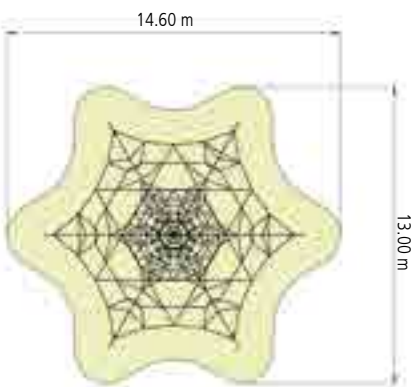





SPIDER 8 rope pyramid with 6 guy lines

Art.no. 5000-8-6

Equipment

1 steel post (Ø 193mm), hot-dip galvanised, with aluminium cap
 3D climbing net structure
 4 M16 turnbuckles, galvanised
 Hercules rope ropes and nets
 (Ø 18mm, 6-strand with steel core)

Technical data

Equipment height:	8.30 m
Space requirement:	12.10 x 14.00 m
Safety zone:	15.00 x 13.50 m
Min. fall protection:	126.40 m ²
Height of fall:	1.80 m
Ground surface:	see table on page 275

Attention!

The space required for the foundations is bigger than the minimum space for the equipment.

Standard colour combination black-red with aluminium connectors.

Upon request in black with orange powder-coated aluminium connectors and SPIDER sign for the post ends.

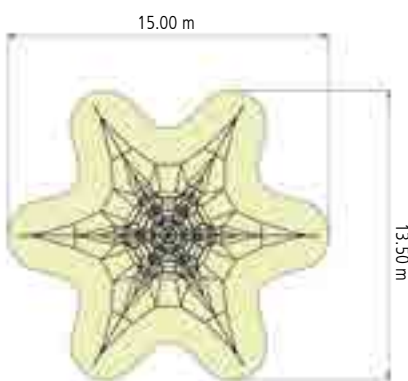

HUCK





Buried ground anchors

Art. no. 4643-3B-100 Additional cost per set

Equipment

1 steel centre mast anchor, hot-dip galvanised

16 steel anchor plates, hot-dip galvanised
(50 x 50 cm)



Cheops pyramid, maxi

Art. no. 4643-3B European design patent

Equipment

1 steel post (Ø 160 mm), hot-dip galvanised, length 6.30 m, with aluminium cap (powder-coated in red)

6 climbing ladders with plastic rungs

2 climbing chimneys

2 horizontal nets (at heights of 1.70 m and 3.40 m)

1 net surface

16 turnbuckles M16, galvanised

Ropes and nets made of Hercules rope (Ø 16 mm, 6-strand, with steel core)

Technical data

Equipment height: 5.60 m

Space requirement: Ø 11.00 m*

Safety zone: Ø 13.00 m

Min. fall protection: 132.50 m²

Height of fall: 1.75 m

Ground surface: see table on page 275

* Please note!

The version with buried ground anchors requires a foundation diameter of Ø 15.00 m.

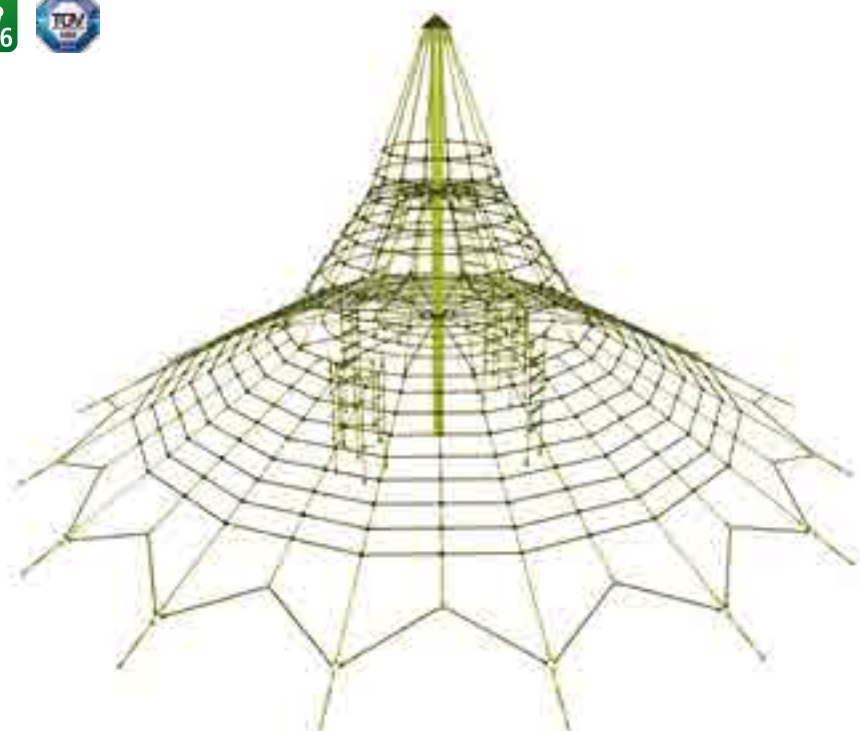
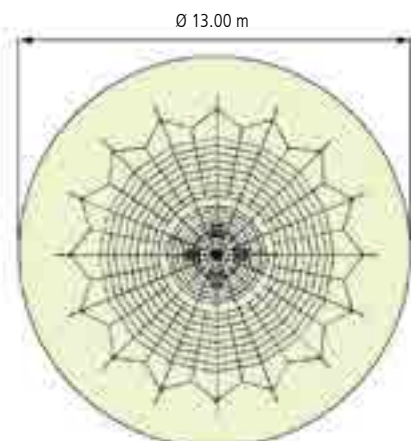





Cheops combination, maxi

Art.no. 4643-3B-10

Equipment

2 steel posts (Ø 160 mm), hot-dip galvanised, length 6.30 m, with aluminium cap (powder-coated in red)

2 net surfaces

1 crossing bridge

12 climbing ladders with plastic rungs

4 climbing chimneys

4 horizontal nets (at heights of 1.70 m and 3.40 m)

32 turnbuckles M16, galvanised

Ropes and nets made of Hercules rope (Ø 16 mm, 6-strand, with steel core)

Technical data

Equipment height:	5.60 m
Space requirement:	25.80 x 11.00 m
Safety zone:	28.70 x 13.00 m
Min. fall protection:	295.00 m ²
Height of fall:	2.00 m
Ground surface:	see table on page 275

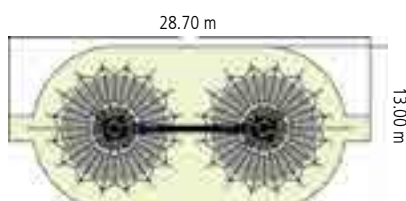
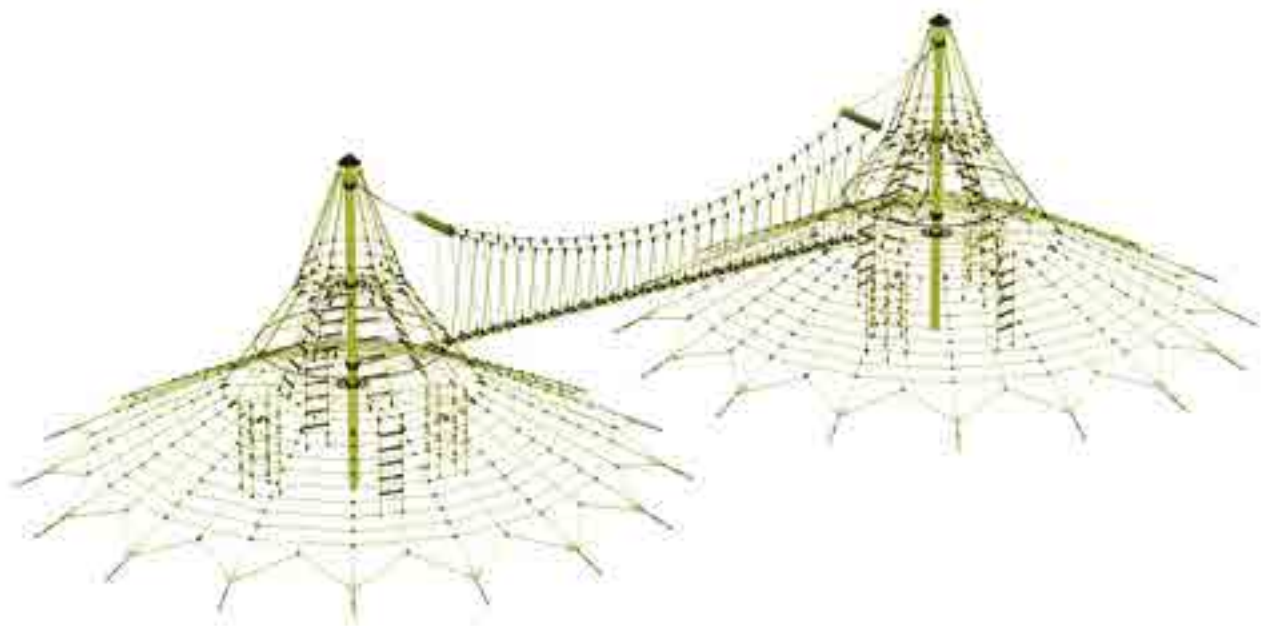





Buried ground anchors

Art. no. 4643-2B-100 Additional cost per set

Equipment

1 steel centre mast anchor, hot-dip galvanised

16 steel anchor plates, hot-dip galvanised
(50 x 50 cm)



Cheops pyramid, midi

Art. no. 4643-2B European design patent

Equipment

1 steel post (Ø 160 mm), hot-dip galvanised,
length 5.00 m, with aluminium cap (powder-
coated in red)

4 swing ladders with plastic rungs

4 climbing ropes

2 horizontal nets (at heights of 1.40 m and 3.10 m)

1 net surface

16 turnbuckles M16, galvanised

Ropes and nets made of Hercules rope
(Ø 16 mm, 6-strand, with steel core)

Technical data

Equipment height: 4.30 m

Space requirement: Ø 8.00 m*

Safety zone: Ø 9.60 m

Min. fall protection: 72.00 m²

Height of fall: 1.50 m

Ground surface: see table on page 275

* Please note!

The version with buried ground anchors requires
a foundation diameter of Ø 11.80 m.

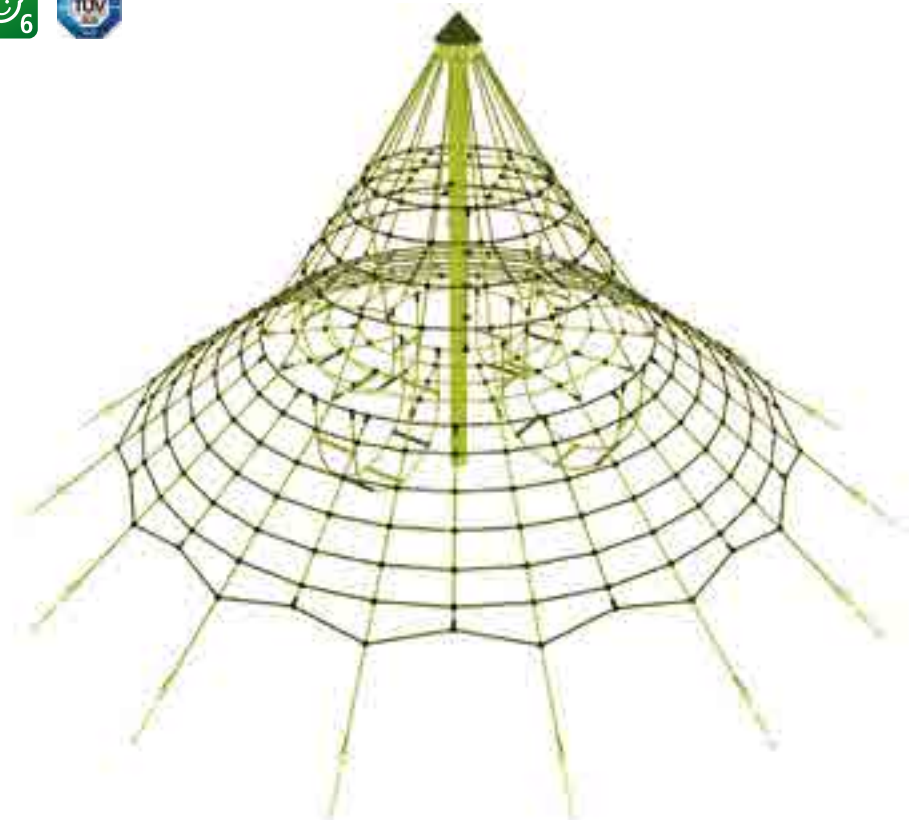
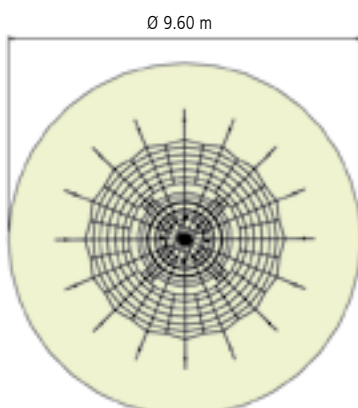





Cheops combination, midi

Art.no. 4643-2B-10

Equipment

2 steel posts (Ø 160 mm), hot-dip galvanised, length 5.00 m, with aluminium cap (powder-coated in red)

2 net surfaces

1 crossing bridge

8 swing ladders with plastic rungs

8 climbing ropes

4 horizontal nets (at heights of 1.40 m and 3.10 m)

32 turnbuckles M16, galvanised

Ropes and nets made of Hercules rope (Ø 16 mm, 6-strand, with steel core)

Technical data

Equipment height: 4.30 m

Space requirement: 18.90 x 8.00 m

Safety zone: 20.60 x 9.60 m

Min. fall protection: 152.00 m²

Height of fall: 1.70 m

Ground surface: see table on page 275

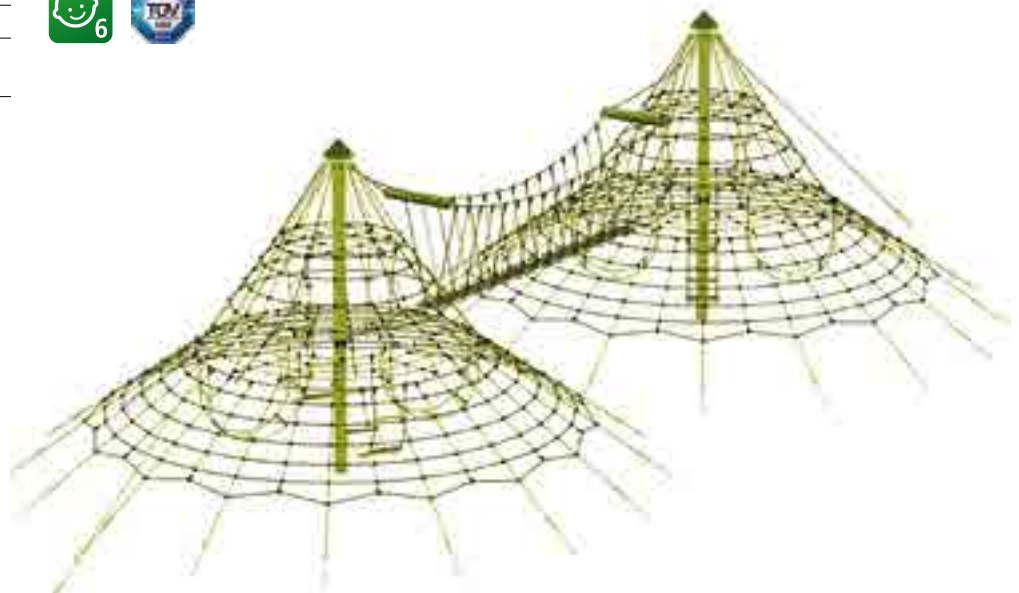
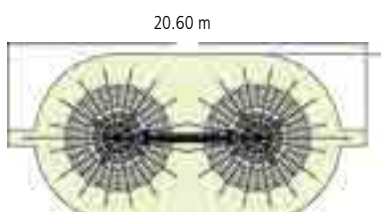





Buried ground anchors

Art. no. 4643-1B-100 Additional cost per set

Equipment

17 steel anchor plates, hot-dip galvanised
(50 x 50 cm)



Cheops pyramid, mini

Art. no. 4643-1B European design patent

Equipment

1 steel post (Ø 102 mm), hot-dip galvanised,
length 4.00 m, with aluminium cap (powder-
coated in red)

1 rope ladder with plastic rungs

1 climbing rope

1 horizontal net

1 net surface

16 turnbuckles M16, galvanised

Ropes and nets made of Hercules rope
(Ø 16 mm, 6-strand, with steel core)

Technical data

Equipment height: 3.60 m

Space requirement: Ø 4.00 m

Safety zone: Ø 6.40 m

Min. fall protection: 32.00 m²

Height of fall: 1.20 m

Ground surface: see table on page 275

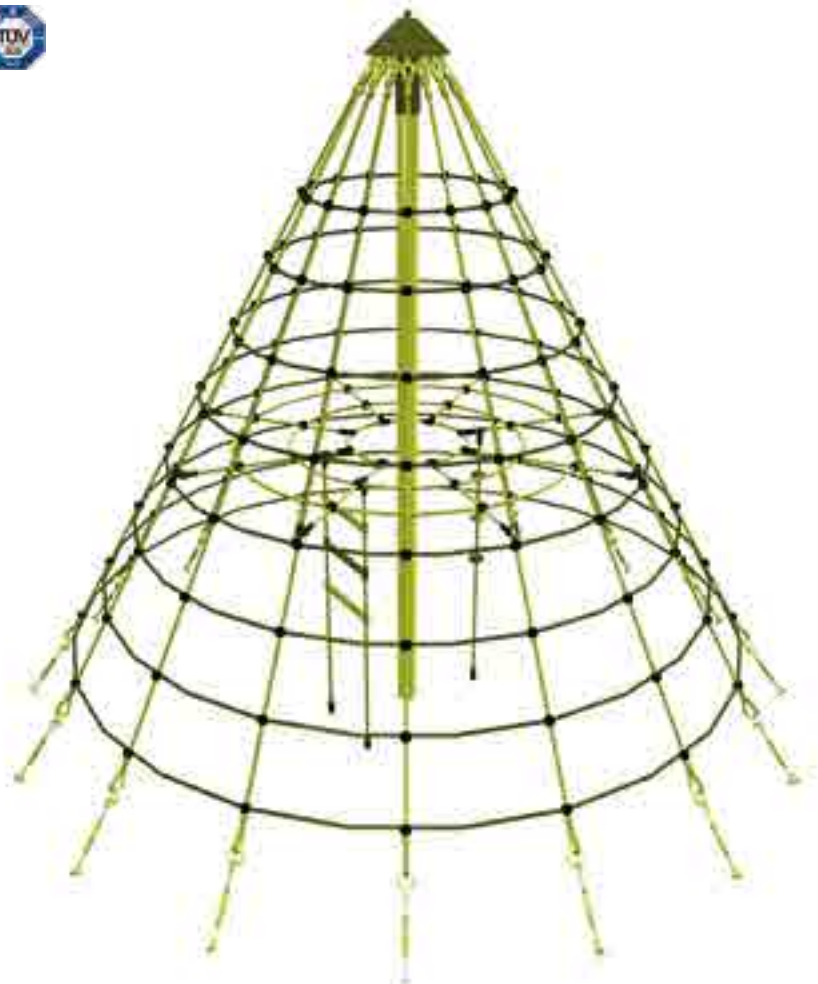
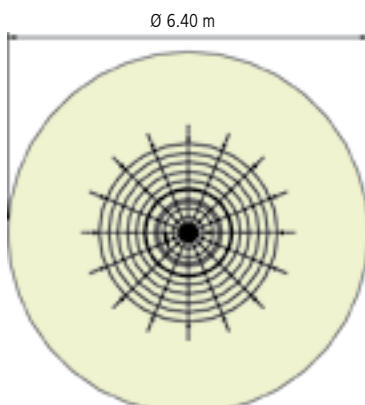



Triops® pyramid, mini

Art.no. 4644-1

Equipment

1 steel post (Ø 102 mm), hot-dip galvanised, length 4.00 m, with aluminium cap (powder-coated in red)

1 net

3 turnbuckles M12, galvanised

Ropes and nets made of Hercules rope (Ø 16 mm, 6-strand, with steel core)

Technical data

Equipment height: 3.15 m

Space requirement: 4.50 x 3.90 m

Safety zone: 6.60 x 6.12 m

Min. fall protection: 26.50 m²

Height of fall: 1.75 m

Ground surface: see table on page 275

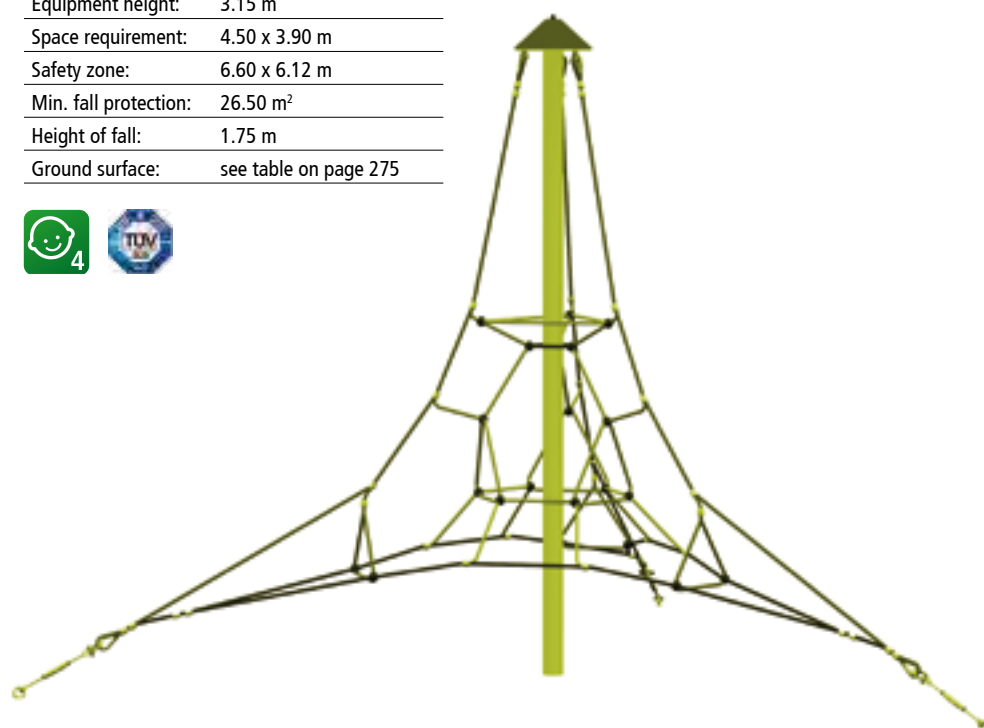
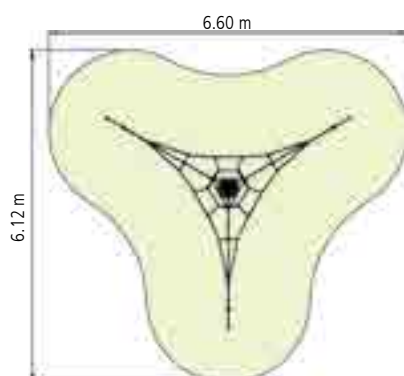



Triops®combination, mini

Art.no. 4644-2

Equipment

2 steel posts (Ø 102 mm), hot-dip galvanised, length 4.00 m, with aluminium cap (powder-coated in red)

1 net with crossing

4 turnbuckles M12, galvanised

Ropes and nets made of Hercules rope (Ø 16 mm, 6-strand, with steel core)

Technical data

Equipment height: 3.15 m

Space requirement: 4.50 x 5.60 m

Safety zone: 6.60 x 8.10 m

Min. fall protection: 42.00 m²

Height of fall: 1.75 m

Ground surface: see table on page 275

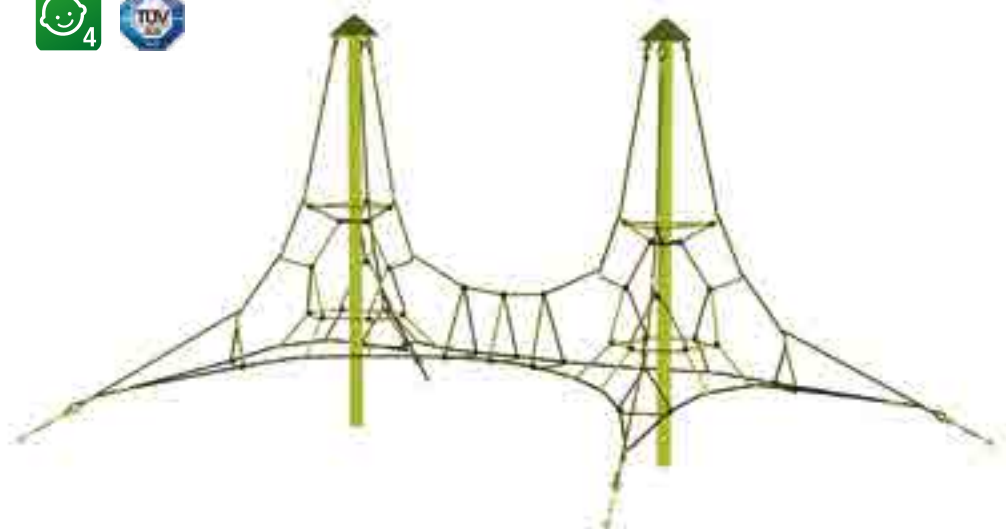
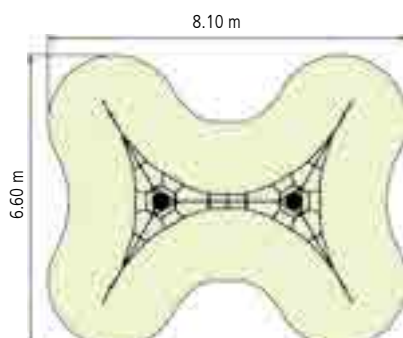



Buried ground anchors

Art. no. 4595-2 Additional cost per set

Equipment

1 steel centre mast anchor, hot-dip galvanised

8 steel anchor plates, hot-dip galvanised (70 x 70 cm)



Rope net tower 1

Art.no. 4595

Equipment

1 steel post (Ø 193 mm), hot-dip galvanised, length 7.00 m, with aluminium cap (powder-coated in red)

2 horizontal nets

1 net surface

8 turnbuckles M16, galvanised

Ropes and nets made of Hercules rope (Ø 16 mm, 6-strand, with steel core)

Technical data

Equipment height: 6.00 m

Space requirement: Ø 9.50 m*

Safety zone: Ø 11.60 m

Min. fall protection: 105.50 m²

Height of fall: 2.00 m

Ground surface: see table on page 275

* Please note!

The version with buried ground anchors requires a foundation diameter of Ø 14.00 m.

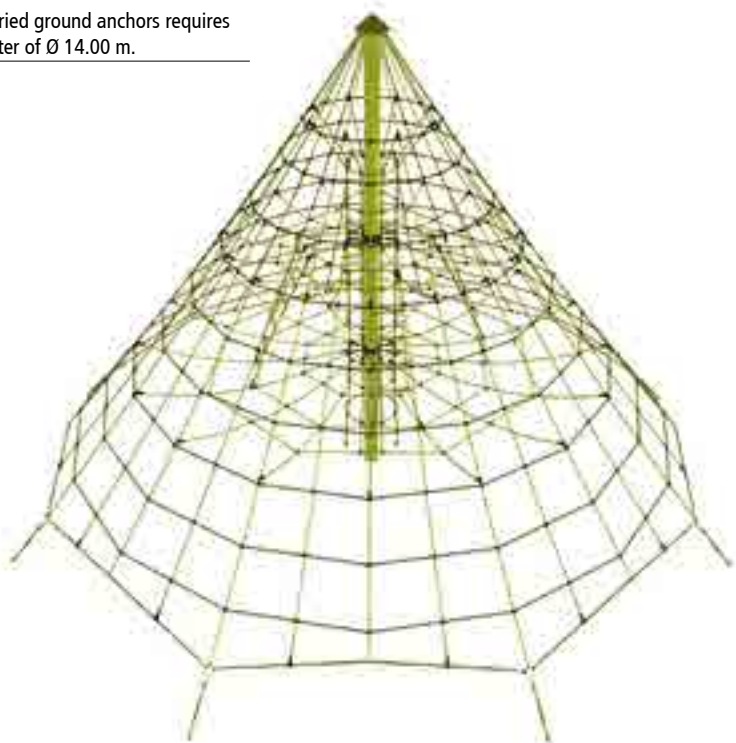
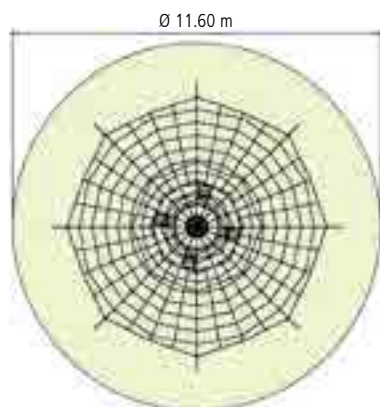



Buried ground anchors

Art. no. 4596-2 Additional cost per set

Equipment

1 steel centre mast anchor, hot-dip galvanised
8 steel anchor plates, hot-dip galvanised
(70 x 70 cm)



Rope net tower 2

Art.no. 4596S

Equipment

1 steel post (Ø 193 mm), hot-dip galvanised, length 5.30 m, with aluminium cap (powder-coated in red)

2 horizontal nets

1 net surface

8 turnbuckles M16, galvanised

Ropes and nets made of Hercules rope (Ø 16 mm, 6-strand, with steel core)

Technical data

Equipment height: 4.50 m

Space requirement: Ø 8.00 m*

Safety zone: Ø 10.00 m

Min. fall protection: 78.50 m²

Height of fall: 1.50 m

Ground surface: see table on page 275

* Please note!

The version with buried ground anchors requires a foundation diameter of Ø 12.60 m.

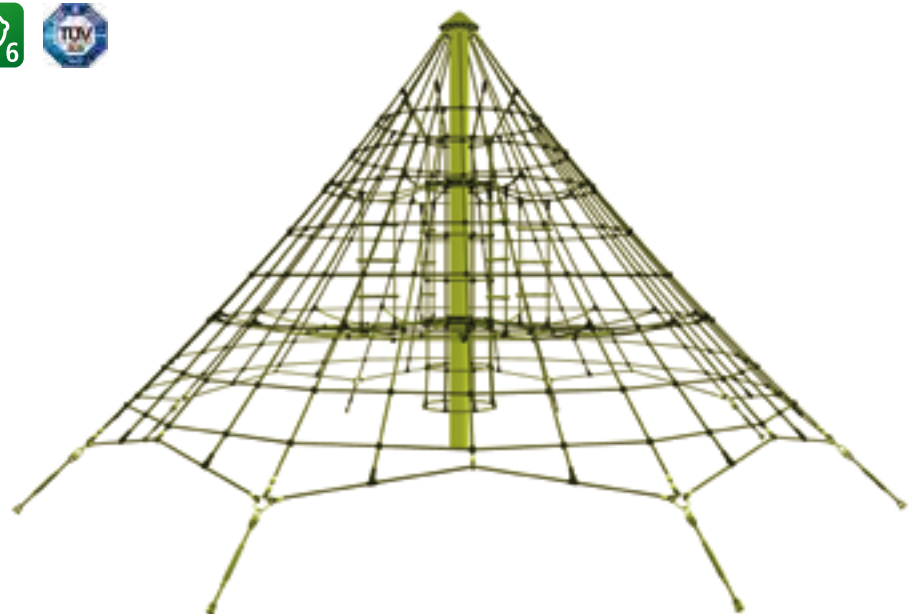
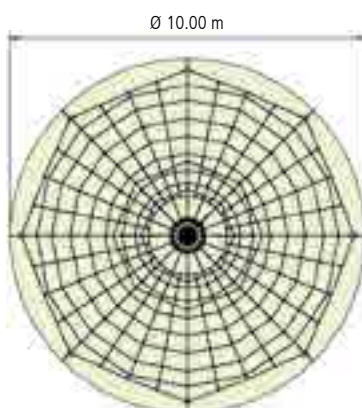





Dino XXL rope net pyramid

Art.no. 10.04.100

DINO rope net pyramids with a large birds nest for resting.

Equipment

- 1 post (Ø 193 mm), hot-dip galvanised, length 9.30 m, with aluminium cap (powder-coated in red)
- 1 ring wound round with rope (Ø 0.90), galvanised, with net base
- 3 rings wound round with rope (Ø 1.90), hot-dip galvanised, with net base
- 1 original HUCK Bird's Nest® (Ø 1.90)
- 1 net surface
- 2 horizontal nets (at heights of 1.40 m and 2.50 m)
- 8 turnbuckles M16, galvanised
- Ropes and nets made of Hercules rope (Ø 16 mm, 6-strand, with steel core)

Technical data

Equipment height:	8.15 m
Space requirement:	Ø 9.50 m
Safety zone:	Ø 12.20 m
Min. fall protection:	117.00 m ²
Height of fall:	1.75 m
Ground surface:	see table on page 275

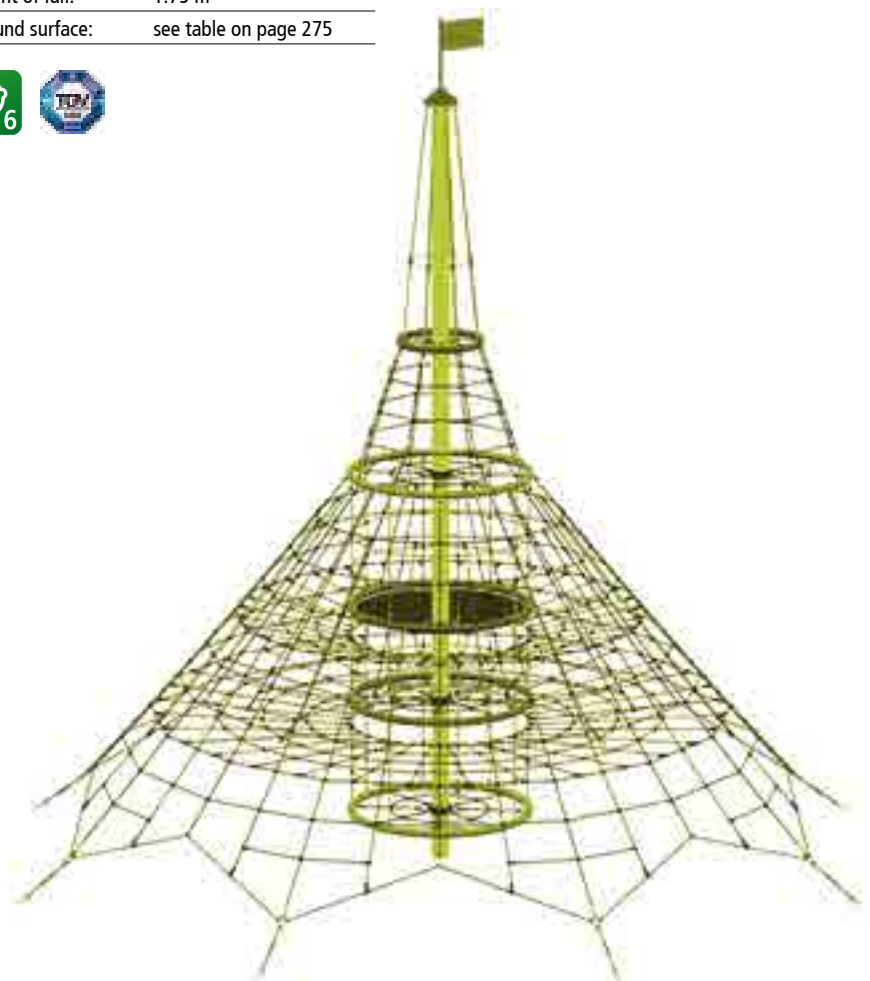
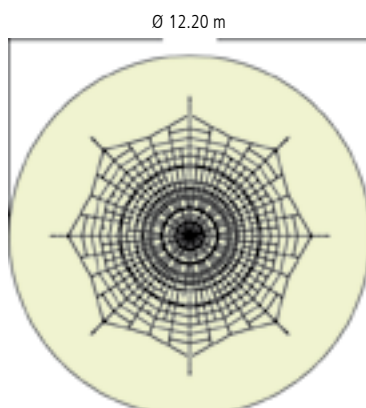





With integrated slide upon request!
(page 279)

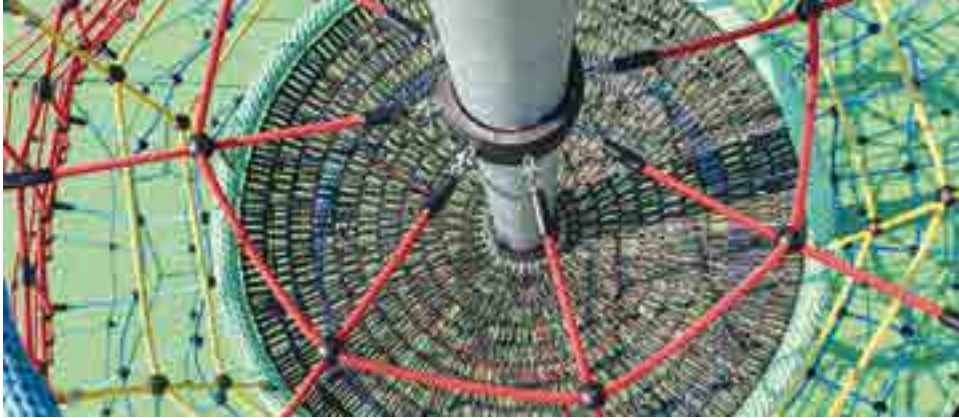

Buried ground anchors

Art. no. 10.01.150 Additional cost per set

Equipment

1 steel centre mast anchor, hot-dip galvanised
8 steel anchor plates, hot-dip galvanised
(70 x 70 cm)



Dino 1 rope net pyramid

Art.no. 10.01.100

DINO rope net pyramids with a large birds nest for resting.

Equipment

1 steel post (Ø 193 mm), hot-dip galvanised, length 7.00 m, with aluminium cap (powder-coated in red)

1 original HUCK Bird's Nest® (Ø 1.90)

3 steel rings wound round with rope (Ø 1.90 m), galvanised, with net base

1 net surface

2 horizontal nets

8 turnbuckles M16, galvanised

Ropes and nets made of Hercules rope (Ø 16 mm, 6-strand, with steel core)

Technical data

Equipment height: 6.50 m

Space requirement: Ø 9.50 m*

Safety zone: Ø 12.20 m

Min. fall protection: 117.00 m²

Height of fall: 1.75 m

Ground surface: see table on page 275

* Please note!

The version with buried ground anchors requires a foundation diameter of Ø 14.00 m.

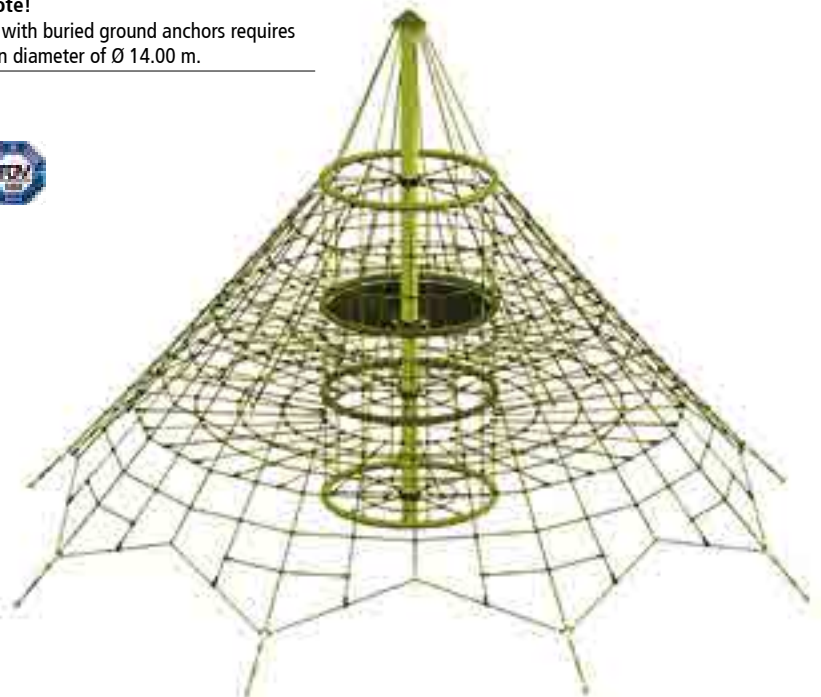
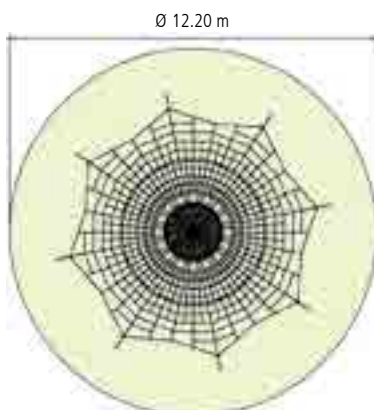



Dino 2 rope net pyramid

Art. no. 10.02.1005

Equipment

1 steel post (Ø 193 mm), hot-dip galvanised, length 5.30 m, with aluminium cap (powder-coated in red)

1 original HUCK Bird's Nest® (Ø 1.90)

2 steel rings wound round with rope (Ø 1.90 m), galvanised, with net base

1 net surface

1 horizontal net

8 turnbuckles M16, galvanised

Ropes and nets made of Hercules rope (Ø 16 mm, 6-strand, with steel core)

Technical data

Equipment height: 4.50 m

Space requirement: Ø 8.00 m*

Safety zone: Ø 10.00 m

Min. fall protection: 78.50 m²

Height of fall: 1.50 m

Ground surface: see table on page 275

* Please note!

The version with buried ground anchors requires a foundation diameter of Ø 12.60 m.



Buried ground anchors

Art. no. 10.02.150 Additional cost per set

Equipment

1 steel centre mast anchor, hot-dip galvanised

8 steel anchor plates, hot-dip galvanised (70 x 70 cm)



DINO rope net pyramids with a large birds nest for resting.

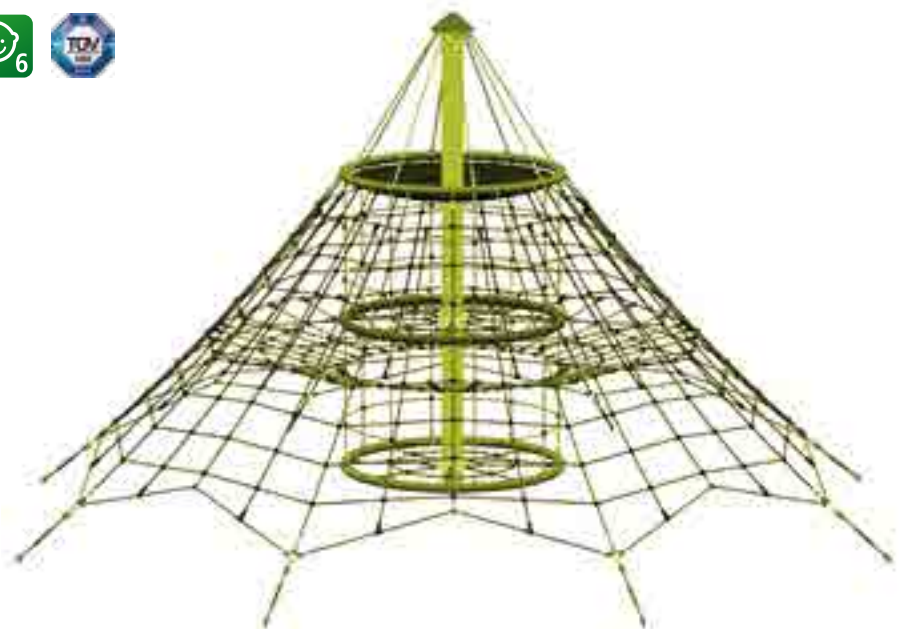
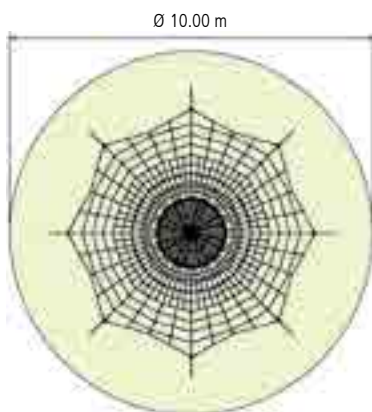



Dino 3 rope net pyramid

Art. no. 10.03.1005

Equipment

1 steel post (Ø 193 mm), hot-dip galvanised, length 3.80 m, with aluminium cap (powder-coated in red)

1 original HUCK Bird's Nest® (Ø 1.90)

1 net surface

8 turnbuckles M16, galvanised

Ropes and nets made of Hercules rope (Ø 16 mm, 6-strand, with steel core)

Technical data

Equipment height: 3.00 m

Space requirement: Ø 5.60 m

Safety zone: Ø 7.50 m

Min. fall protection: 44.50 m²

Height of fall: 1.50 m

Ground surface: see table on page 275



Buried ground anchors

Art. no. 10.03.150 Additional cost per set

Equipment

8 steel anchor plates, hot-dip galvanised (70 x 70 cm)



DINO rope net pyramids with a large birds nest for resting.

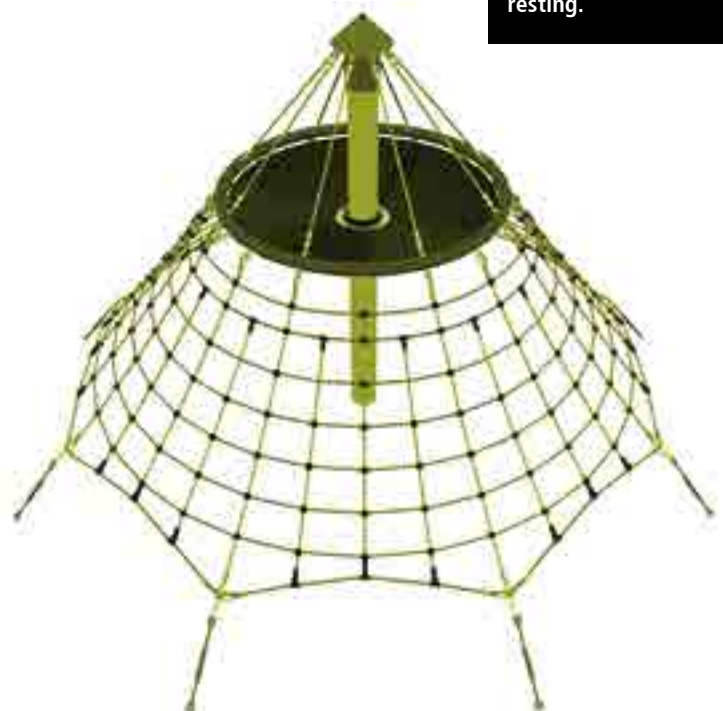
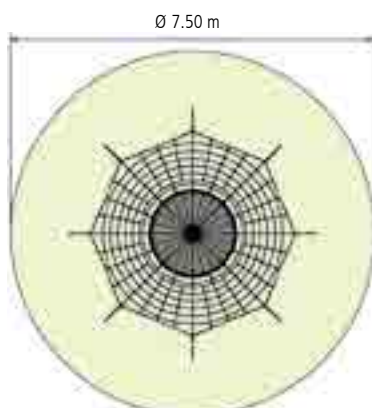



Buried ground anchors

Art. no. 4641-1-100 Additional cost per set

Equipment

8 steel anchor plates, hot-dip galvanised (50 x 50 cm)



Super-climb, maxi

Art.no. 4641-1

Equipment

1 steel post (Ø 102 mm), hot-dip galvanised, length 6.00 m, with aluminium cap (powder-coated in red)

1 net surface

2 horizontal nets

8 turnbuckles M16, galvanised

Ropes and nets made of Hercules rope (Ø 16 mm, 6-strand, with steel core)

Technical data

Equipment height: 5.00 m

Space requirement: 6.20 x 6.20 m

Safety zone: 9.25 x 9.25 m

Min. fall protection: 80.00 m²

Height of fall: 2.00 m

Ground surface: see table on page 275





Buried ground anchors

Art. no. 4641-2-100 Additional cost per set

Equipment

8 steel anchor plates, hot-dip galvanised (50 x 50 cm)



Super-climb, midi

Art.no. 4641-2

Equipment

1 steel post (Ø 102 mm), hot-dip galvanised, length 4.30 m, with aluminium cap (powder-coated in red)

1 net surface

8 turnbuckles M16, galvanised

Ropes and nets made of Hercules rope (Ø 16 mm, 6-strand, with steel core)

Technical data

Equipment height: 3.50 m

Space requirement: 6.20 x 6.20 m

Safety zone: 9.25 x 9.25 m

Min. fall protection: 77.50 m²

Height of fall: 2.50 m

Ground surface: see table on page 275



Buried ground anchors

Art. no. 4641-3-100 Additional cost per set

Equipment

4 steel anchor plates, hot-dip galvanised (50 x 50 cm)



Super-climb, mini

Art.no. 4641-3

Equipment

1 steel post (Ø 60 mm), hot-dip galvanised, length 2.90 m, with aluminium cap (powder-coated in red)

1 net surface

4 turnbuckles M16, galvanised

Ropes and nets made of Hercules rope (Ø 16 mm, 6-strand, with steel core)

Technical data

Equipment height: 2.50 m

Space requirement: 3.90 x 3.90 m

Safety zone: 6.95 x 6.95 m

Min. fall protection: 46.00 m²

Height of fall: 1.50 m

Ground surface: see table on page 275



Hally Gally series – it's all action



It really is all action when playing on the Hally Gally components: The Hally Gally carousels spin and bob up and down at the same time thanks to their unique mechanism. As a single attraction or as the highlight of every playground – this spinning play equipment in numerous designs provides a colourful variety for different age groups. And large and small trampolines invite to hours of rollicking jumping romps. Children feel like Tarzan in the jungle when they climb and swing on a rope swing.

In addition to the legally required safety zone, which is fitted with appropriate fall protection, we recommend in some cases to expand the safety zone with an additional area whose ground cover does not have to comply with EN norms. The stipulated fall protection should seamlessly and without fixed frames give way to the recommended additional safety zone (lawn, etc.) and should not be obstructed by benches and other items.

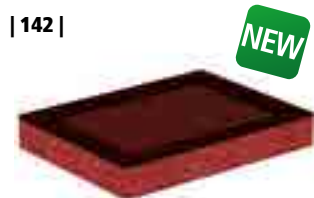

Trampolines



Pendulum seat combination

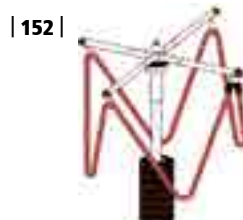

Liana carousel



Space capsule



Climbing circus

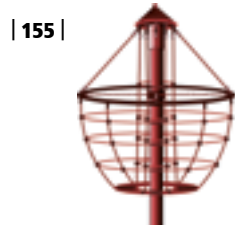

Beehive carousel



Epsilon



Larg climbing pyramid

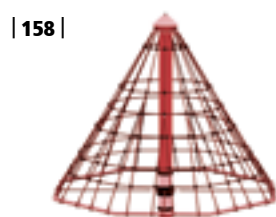

Mini climbing pyramid



Tower carousel



Mini tower carousel

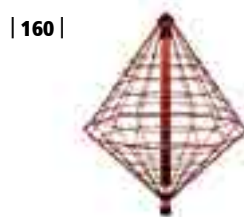

Climbing whirl

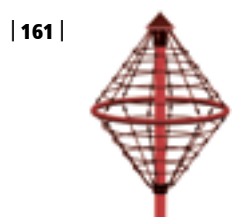

Climbing whirl, midi



Bird's nest carousel
Mini bird's nest carousel



Spiral carousel



Mushroom carousel
Witch's carousel



Hally Gally trampolines

- The tried-and-tested original
- Robust and ready to take any strain
- Easy to install and maintain
- In a variety of shapes and sizes
- Can be delivered at short notice
- Delivered fully assembled and ready for play



The advantages of the Hally Gally trampoline series

Jumping mat

- Extremely durable jumping mat made from special, environmentally friendly and soft recycled rubber segments with a fabric underlayer
- Robustly linked by firm wire rope with high-quality coating (ropes placed at 4.50 cm all around)
- Neutral colour, black



Spring suspension

- Depending on trampoline size, up to 174 specially made steel springs (high-quality hot-dip galvanised coating, not electrolytically zinc plated), providing unfaltering draught pressure for many years
- Secure spring covers made from robust recycled rubber, all the way into the jumping area
- Springs are evenly spread around the edge to account for the shape and applied force



Fall protection panels

- Durable, high-quality and shock-absorbent fall protection
- Complies with the requirements of EN 1176 up to a fall height of 1.50 m
- Special 2-component glue, applied to the whole area, for a permanent and secure hold
- colour: red brown (black or graffiti on request)



Frame construction

- Complete steel panel frame with reinforced corners and extra-strong galvanised coating
- Long life construction for permanent installation, even in damp soil
- Secure and stable suspension solution for the entire spring assembly
- Highly durable abrasion protection on the contact areas below the frame



Installation equipment for dig-in frames

- Compact, additional frame construction for dig-in installations made from completely hot-dip galvanised steel panels
- No concrete works required, therefore no multiple deliveries and setting times
- Stable and permanent connection with the trampoline



Maintenance

- Equipment is completely maintenance-free
- Entire area below trampoline can be accessed for cleaning by opening the trampoline or lifting it out
- Individual parts do not have to be disassembled
- Lifting equipment specially designed for our trampolines is available separately





Version for installation in the ground (art. no. 20.02.125), integrated into the lawn.

Trampoline 2000

Art. no. 20.02.120 for erecting on surfaces

Art. no. 20.02.125 for installation in the ground

Equipment

Jumping area made from non-slip, vandal-proof mat for medium height jumps surrounded by fall protection panels (lawn is sufficient outside this area)

Frame can be completely opened or lifted out

Technical data

Jumping area: 1.75 m x 2.50 m

Outer dimensions: 2.25 m x 3.00 m

Safety zone: 4.75 x 5.50 m

Min. fall protection: 19.40 m²

Height of fall: 1.50 / 1.00 m

Ground surface: see table on page 275



Version for installation in the ground (art. no. 20.02.125), Several trampolines installed in a line with safety surfacing to make one course.

TRIED AND TESTED FOR MORE THAN 20 YEARS!

Offers guaranteed quality in long-term use and is popular among all age groups, thus making it the perfect break-time equipment in school playgrounds!

Delivered completely ready to play on for simple set up on grass or sand surfaces, or alternatively for ground-level installation with concrete foundations or for quick, simple installation with buried/dig-in frames.

Due to the design the jumping height is reduced to a safe extent!



Version for erecting on surfaces (art. no. 20.02.120) (height approx. 45 cm)



Trampolin „Circus“

Art. no. 20.02.112 includes dig-in frame as standard

Equipment

Jumping area made from non-slip, vandal-proof mat for medium height jumps

Complete frame can be lifted out for cleaning

Technical data

Jumping area: Ø 1.30 m

Outer dimensions: Ø 1.90 m

Safety zone: 4.30 m

Min. fall protection: 11.70 m²

Height of fall: 1.00 m

Ground surface: see table on page 275

HOW PRACTICAL!

Delivery includes buried frames made from GRP plastic for inexpensive, simple and quick assembly. This eliminates the need for concrete material, boring setting times and multiple trips to the building site. Detailed info on this on page 249.

Also available with closed jumping mat!

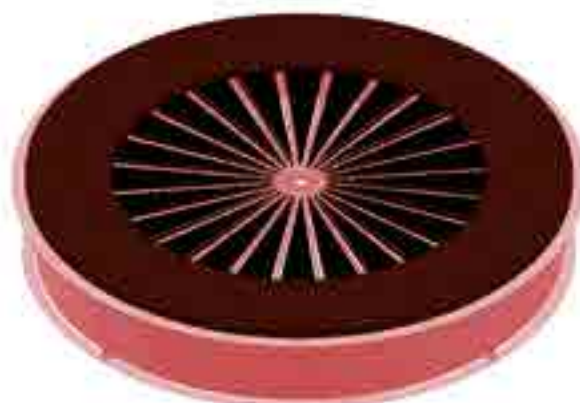



Trampoline "Saturn"

Art. no. 20.02.111 includes dig-in frame as standard

Equipment

Jumping area made from closed rubber mat
surrounded by fall protection panels
(lawn is sufficient outside this area)
Complete frame can be lifted out for cleaning

Technical data

Jumping area:	2.00 x 1.00 m
Outer dimensions:	2.50 x 1.50 m
Safety zone:	5.00 x 4.00 m
Min. fall protection:	12.90 m ²
Height of fall:	1.00 m
Ground surface:	see table on page 275



HOW PRACTICAL!

Delivery includes buried frames made from GRP plastic for inexpensive, simple and quick assembly. This eliminates the need for concrete material, boring setting times and multiple trips to the building site
Detailed info on this on page 249





“Triangulum” Trampoline

Art.no. 20.02.103

Equipment

Jumping area slip-proof, anti-vandalism, mat for medium jumping height

Frame can be completely removed for cleaning

Technical data

Outer dimensions: 3.00 x 2.60 m

Safety zone: 5.50 x 5.10 m

Min. fall protection: 16.10 m²

Height of fall: 1.00 m

Ground surface: see table on page 275





Mini trampoline

Art. no. 20.02.122 for erecting on surfaces

Art. no. 20.02.126 for installation in the ground

Equipment

Jumping area made from non-slip, vandal-proof mat for medium height jumps

surrounded by fall protection panels
(lawn is sufficient outside this area)

Complete frame can be lifted out or turned over for cleaning

Technical data

Jumping area: 1.25 m x 1.25 m

Outer dimensions: 1.75 m x 1.75 m

Safety zone: 4.25 m x 4.25 m

Min. fall protection: 15.00 m²

Height of fall: 1.50 / 1.00 m

Ground surface: see table on page 275



Also available with closed jumping mat!



Trampoline "Piccolo"

Art. no. 20.02.116 for installation in the ground with surrounding fall protection panels

Art. no. 20.02.117 for erecting on surfaces

Art. no. 20.02.118 for installation in natural ground

Equipment

Jumping area made from closed rubber mat
(incl. 5 drainage holes)

surrounded by fall protection panels
(lawn is sufficient outside this area)



Technical data

Jumping area: 0.75 m x 0.75 m

Outer dimensions: 1.25 m x 1.25 m

Safety zone: 3.75 m x 3.75 m

Min. fall protection: 12.50 m²

Height of fall: 1.50 / 1.00 m

Ground surface: see table on page 275



Dig-in frame for permanently installed trampolines

Art. no. 20.02.123 for trampoline 2000
(20.02.125)

Art. no. 20.02.127 for Mini trampoline
(20.02.126)

Equipment

Steel panel frame (suitable for the measurements
of the installed trampoline – time-saving installation
without requiring concrete works)

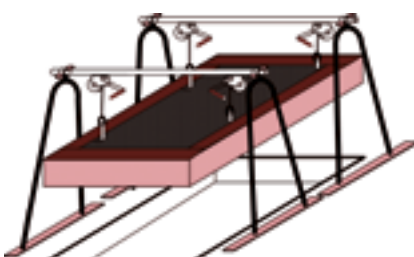
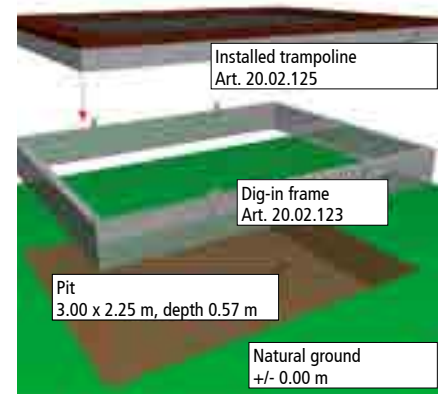

Lifting equipment

Art. no. 20.02.124 for safely lifting the trampoline



Wheelchair Trampoline “Rolli”

Art.no. 20.02.115

Equipment

Jumping area made from non-slip, vandal-proof mat for medium height jumps

surrounded by fall protection panels (lawn is sufficient outside this area)

Frame can be opened or lifted out

Technical data

Jumping area: 0.90 x 2.50 m

Outer dimensions: 1.40 x 3.00 m

Safety zone: 3.90 x 5.50 m

Min. fall protection: 17.25 m³

Height of fall: 1.00 m

Ground surface: see table on page 275



Being active is good for you – and that goes equally for people with limited mobility. The trampoline “Rolli” was developed for wheelchair users. The trampoline is inserted in the ground and can be safely and easily accessed thanks to its bevelled edge panels. The flexible trampoline area produces gentle swinging and swaying motions regardless of the weight of a person. As the size is compact, the companion can be in direct contact with the wheelchair user – this is important, for example, for people with severe disabilities.

You can find all obstacle-free rope play equipment in the section “Obstacle-free rope play equipment” starting on page 204.



Upon request also in combination with sun protection sails and guy ropes for self-contained examples! (page 227)

This picture shows a “Rolli” trampoline with double access ramp on one side (customer requirement)





Trampoline 2012

Art.no. 20.02.108

Equipment

Jumping area made from non-slip, vandal-proof mat for medium height jumps

surrounded by fall protection panels (lawn is sufficient outside this area)

includes integrated dig-in frame

Technical data

Jumping area: 1.50 x 2.00 m

Outer dimensions: 2.00 x 2.50 m

Safety zone: 4.50 x 5.00 m

Min. fall protection: 17.50 m³

Height of fall: 1.00 m

Ground surface: see table on page 275



MADE IN GERMANY!

The trampoline 2012 is delivered completely ready to play for immediate set up. The integrated, fully-welded and galvanised buried frame provides a quick and easy assembly without any concreting.

For installation simply dig out a 45cm deep pit, set equipment down and fill in. The jumping mat made from recycling rubber is extremely abrasion-resistant and can be opened from the top for any necessary cleaning.

HUCK provides a 5 year guarantee for the Trampoline 2012!



Trampoline 2014

Art.no. 20.02.102

Equipment

Incl. rubber-link mat that can be hung out with 1 row fall protection boards and adhesive with integrated buried frame

Technical data

Jumping area:	1.35 x 1.35 m
Outer dimensions:	2.25 x 2.25 m
Safety zone:	4.75 x 4.75 m
Min. fall protection:	22.60 m ³
Height of fall:	1.00 m
Ground surface:	see table on page 275



Installation without concreting and without separate buried frame!



Pendulum seat combination

Art.no. 20.01.040

Equipment

1 steel mast (Ø 20 cm), length 3.80 m

4 seesaw beams (Ø 14 cm), length 180 cm

Technical data

Equipment height: 3.10 m

Space requirement: Ø 3.80 m

Safety zone: legally required Ø 11.00 m
recommended Ø 14.00 m

Min. fall protection: 95.50 m²

Height of fall: 1.50 m

Ground surface: see table on page 275





Standard design with tyre cushioning!

Liana carousel

Art.no. 20.01.090

Equipment

- 1 steel mast (Ø 20 cm), length 3.80 m
- 4 seesaw beams (Ø 14 cm), length 1.65 m
- 1 spin-seesaw mechanism with maintenance-free sliding bearing
- 1 palette of square-mesh PP rope, Ø approx. 90 mm) with internal steel rope Ø 12 mm

Technical data

- Equipment height: 3.40 m
- Space requirement: Ø 3.50 m
- Safety zone: legally required Ø 8.00 m
recommended Ø 11.00 m
- Min. fall protection: 50.20 m²
- Height of fall: 1.00 m
- Ground surface: see table on page 275





Space capsule

Art.no. 20.01.020

Equipment

- 1 steel mast (Ø 20 cm), length 3.80 m, with PA mast protector
- 4 seesaw beams (Ø 14 cm), length 1.65 m
- 1 spin-seesaw mechanism with maintenance-free sliding bearing
- 1 pack of space capsule accessories
- 1 bunch of aluMinium rings
- Ropes and nets made of Hercules rope (Ø 16 mm, 6-strand, with steel core)

Technical data

- Equipment height: 3.40 m
- Space requirement: Ø 3.50 m
- Safety zone: legally required Ø 8.00 m
recommended Ø 11.00 m
- Min. fall protection: 50.20 m²
- Height of fall: 1.00 m
- Ground surface: see table on page 275





Climbing circus

Art.no. 20.01.050

Equipment

- 1 steel mast (Ø 20 cm), length 3.80 m
- 4 seesaw beams (Ø 14 cm), length 1.65 m
- 1 spin-seesaw mechanism with maintenance-free sliding bearing
- 1 pack of netting
- Ropes and nets made of Hercules rope (Ø 16 mm, 6-strand, with steel core)

Technical data

- Equipment height: 3,40 m
- Space requirement: Ø 3,50 m
- Safety zone: legally required Ø 8,00 m
recommended Ø 11,00 m
- Min. fall protection: 50,20 m²
- Height of fall: 1,00 m
- Ground surface: see table on page 275





Beehive carousel

Art. no. 20.05.120 for installation in the ground

Equipment

1 steel mast (Ø 16 cm), length 3.00 m
with buried ground anchor

1 component (Ø 1.90 m)

Ring height 1.70 m

Ropes and nets made of Hercules rope
(Ø 16 mm, 6-strand, with steel core)

Technical data

Equipment height: 2.10 m

Space requirement: Ø 2.00 m

Safety zone: legally required Ø 6.00 m
recommended Ø 9.00 m

Min. fall protection: 28.50 m²

Height of fall: 1.70 m

Ground surface: see table on page 275



HOW PRACTICAL!

The equipment is assembled and can be played upon within the shortest amount of time. For simple and quick assembly HUCK offers dig-in ground anchors, which eliminate the need for concreting and bothersome setting time. Detailed info on this on Page 249.



Ellipsilon

Art.no. 20.01.170

Equipment

- 1 steel mast (Ø 127 mm), length 3.80 m
- 1 spinning shoe
- 2 elliptical steel rings wound round with rope (Ø 2.20 x 1.30 m), galvanised, with net base
- 1 net
- Ropes made from Hercules rope (Ø 16 mm, 6-strand, with steel core)

Technical data

- Equipment height: 2.90 m
- Space requirement: Ø 2.30 m
- Safety zone: legally required Ø 7.00 m
recommended Ø 11.00 m
- Min. fall protection: 38.50 m²
- Height of fall: 2.00 m
- Ground surface: see table on page 275





Large climbing pyramid

Art.no. 20.01.060

Equipment

1 steel mast (Ø 20 cm), length 5.00 m, with PA mast protector

1 spinning shoe

1 pack rubber flooring with net (Ø 1.90 m)

1 handwheel

1 bunch of aluMinium rings

Ropes and nets made of Hercules rope (Ø 16 mm, 6-strand, with steel core)

Technical data

Equipment height: 4.15 m

Space requirement: Ø 3.50 m

Safety zone: legally required Ø 8.00 m
recommended Ø 11.00 m

Min. fall protection: 50.20 m²

Height of fall: 2.80 m

Ground surface: see table on page 275





Mini climbing pyramid

Art.no. 20.01.070

Equipment

- 1 steel mast (Ø 20 cm), length 3.80 m, with PA mast protector
- 1 spinning shoe
- 1 pack of netting
- Ropes and nets made of Hercules rope (Ø 16 mm, 6-strand, with steel core)

Technical data

- Equipment height: 2.95 m
- Space requirement: Ø 3.50 m
- Safety zone: legally required Ø 8.00 m
recommended Ø 11.00 m
- Min. fall protection: 50.20 m²
- Height of fall: 2.00 m
- Ground surface: see table on page 275



Tower carousel

Art.no. 20.01.150

Equipment

- 1 steel mast (Ø 20 cm), length 5.00 m, with PA mast protector
- 1 component (Ø 2.00 m)
- Ropes and nets made of Hercules rope (Ø 16 mm, 6-strand, with steel core)

Technical data

- Equipment height: 4.15 m
- Space requirement: Ø 2.00 m
- Safety zone: legally required Ø 8.00 m
recommended Ø 11.00 m
- Min. fall protection: 50.20 m²
- Height of fall: 2.80 m
- Ground surface: see table on page 275





Mini tower carousel

Art.no. 20.01.151

Equipment

1 steel mast (Ø 160 mm), 3.80 m long, with plastic mast protection, to be concreted in.

1 original HUCK birds nest

Ropes and nets made of Hercules rope (Ø 16 mm, 6-strand, with steel core)

Technical data

Equipment height: 2.80 m

Space requirement: Ø 1.40 m

Safety zone: legally required Ø 6.00 m
recommended Ø 11.00 m

Min. fall protection: 28.50 m²

Height of fall: 1.50 m

Ground surface: see table on page 275





Climbing whirl

Art.no. 20.01.130

Equipment

1 steel mast (Ø 20 cm), length 5.00 m, with PA mast protector

1 net

1 spinning shoe

1 pack of netting

1 bunch of aluMinium rings

Ropes and nets made of Hercules rope (Ø 16 mm, 6-strand, with steel core)

Technical data

Equipment height: 4.15 m

Space requirement: Ø 3.50 m

Safety zone: legally required Ø 8.00 m
recommended Ø 11.00 m

Min. fall protection: 50.20 m²

Height of fall: 2.50 m

Ground surface: see table on page 275





Climbing whirl, midi

Art.no. 20.01.135

Equipment

1 Steel mast (Ø 1.59 m), length 3.80 m

1 net

1 component (Ø 1.90 m)

1 spinning shoe

Ropes and nets made of Hercules rope
(Ø 16 mm, 6-strand, with steel core)

Technical data

Equipment height: 2.95 m

Space requirement: Ø 2.00 m

Safety zone: legally required Ø 7.00 m
recommended Ø 10.00 m

Min. fall protection: 38.50 m²

Height of fall: 1.70 m

Ground surface: see table on page 275





Bird's nest carousel

Art.no. 20.01.080

Equipment

- 1 steel mast (Ø 20 cm), length 3.80 m, with PA mast protector
- 1 spinning shoe
- 1 original HUCK Bird's Nest® (Ø 1.90)
- 1 handwheel
- Ropes and nets made of Hercules rope (Ø 16 mm, 6-strand, with steel core)

Technical data

- Equipment height: 2.95 m
- Space requirement: Ø 2.00 m
- Safety zone: legally required Ø 6.00 m
recommended Ø 9.00 m
- Min. fall protection: 28.50 m²
- Height of fall: 0.80 m
- Ground surface: see table on page 275



Mini bird's nest carousel

Art.no. 20.06.130 for installation in the ground

Equipment

- 1 steel mast (Ø 16 cm) with buried ground anchor, with PA mast protector
special paint included in delivery
- 1 handwheel
- 1 component (Ø 1.40 m)
- Ropes and nets made of Hercules rope (Ø 16 mm, 6-strand, with steel core)

Technical data

- Equipment height: 2.10 m
- Space requirement: Ø 1.40 m
- Safety zone: legally required Ø 5.50 m
recommended Ø 8.00 m
- Min. fall protection: 24.00 m²
- Height of fall: 0.80 m
- Ground surface: see table on page 275



Mast protector made from stainless steel ensures smooth spinning enjoyment!

HOW PRACTICAL!

The equipment is assembled and can be played upon within the shortest amount of time. For simple and quick assembly HUCK offers dig-in ground anchors, which eliminate the need for concreting and bothersome setting time. Detailed info on this on Page 249.



Spiral carousel

Art.no. 20.01.120

Equipment

1 steel mast (Ø 20 cm), length 3.80 m, with PA mast protector

1 spinning shoe

with steel rope link floor (Ø 1.90 m)

1 pack net flooring

Ropes and nets made of Hercules rope (Ø 16 mm, 6-strand, with steel core)

Technical data

Equipment height: 2.95 m

Space requirement: Ø 2.00 m

Safety zone: legally required Ø 7.00 m
recommended Ø 11.00 m

Min. fall protection: 38.50 m²

Height of fall: 2.00 m

Ground surface: see table on page 275





Mushroom carousel

Art.no. 20.05.110

Equipment

- 1 oak post (Ø 20 cm), length 2.20 m, with steel plates
- 1 component (Ø 2.00 m)
- Ropes and nets made of Hercules rope (Ø 16 mm, 6-strand, with steel core)

Mushroom carousel with steel mast, concrete-in version

Art.no. 20.05.110S

Technical data

- Equipment height: 1.20 m
- Space requirement: Ø 2.00 m
- Safety zone: legally required Ø 6.00 m
recommended Ø 8.00 m
- Min. fall protection: 28.50 m²
- Height of fall: 1.00 m
- Ground surface: see table on page 275



Witch's carousel

Art.no. 20.06.150 for installation in the ground

Equipment

- 1 steel mast with buried ground anchor (Ø 16 cm), length 3.00 m
special paint included in delivery
- 1 component with ring (Ø 2.00 m)
- Ropes and nets made of Hercules rope (Ø 16 mm, 6-strand, with steel core)

Technical data

- Equipment height: 2.25 m
- Space requirement: Ø 2.00 m
- Safety zone: legally required Ø 6.00 m
recommended Ø 9.00 m
- Min. fall protection: 28.50 m²
- Height of fall: 1.00 m
- Ground surface: see table on page 275



HOW PRACTICAL!

The equipment is assembled and can be played upon within the shortest amount of time. For simple and quick assembly HUCK offers dig-in ground anchors, which eliminate the need for concreting and bothersome setting time. Detailed info on this on Page 249.

Original HUCK Bird's Nest® + swings = a dynamic experience

Swings are one of a playground's main attractions. Children love to swing high in the air. HUCK therefore offers every type of swing option a child could possibly want. Whether for toddlers, kindergarten or primary school children or adults with limited mobility, HUCK's product range has the right solution for everyone. For inseparable friends and families, HUCK also offers a special type of product – the original HUCK Bird's Nest®. In various colours and sizes, and with extra-strong padding, it provides the perfect framework for a dynamic swinging experience for two or for the whole family. Relevant accessories can be found from page 175 onwards.



Douglas fir swing frame



Douglas fir swing frame, long



Arch swing



"Junior" swing frame



Steel long swing frame



Mini M-swing



"Midi" easy-swing



"Swing bed" easy-swing



"Honeycomb nest" easy-swing



Original Huck Bird's Nest®



Maintenance and repair solutions



Partner swings



Single swings



Swing hooks and joints



Douglas fir swing frame

Art. no. 4577-1-200 Suspension height 2.00 m

Art. no. 4577-1-250 Suspension height 2.50 m

Suitable connecting parts
can be found on page 175 onwards!

Equipment

- 4 douglas fir posts (Ø 160 mm), with post shoes and plastic caps
- 1 Douglas fir head beam (Ø 180 mm), length 4.00 m, with plastic caps
- Without hanging components and suspension bearings

Technical data

Suspension height:	2.00 m	2.50 m
Equipment height:	2.35 m	2.75 m
Space requirement:	4.20 x 4.00 m	4.20 x 4.00 m
Safety zone:	4.20 x 7.30 m	4.20 x 8.20 m
Min. fall protection:	31.00 m ²	34.50 m ²
Height of fall for single-seat swings:	1.40 m	1.60 m
for bird's nest:	2.10 m	2.35 m
Ground surface:	see table on page 275	see table on page 275





Douglas fir swing frame long

Art. no. 4577-2-200 Suspension height 2.00 m

Art. no. 4577-2-250 Suspension height 2.50 m

Equipment

4 douglas fir posts (Ø 160 mm), with post shoes and plastic caps

1 Douglas fir head beam (Ø 180 mm), length 6.80 m, with plastic caps

Without hanging components and suspension bearings

Technical data

Suspension height:	2.00 m	2.50 m
Equipment height:	2.35 m	2.75 m
Space requirement:	6.80 x 4.00 m	6.80 x 4.00 m
Safety zone:	10.00 x 7.30 m	10.00 x 8.20 m
Min. fall protection:	73.00 m ²	82.00 m ²
Height of fall for single-seat swings:	1.40 m	1.60 m
for bird's nest:	2.10 m	2.35 m
Ground surface:	see table on page 275	see table on page 275



Recommended hanging components:

Original HUCK Bird's Nest®

Art. no. 4650 (see page 175)

Climbing chimney carousel with ground anchors

Art. no. 4611 (see page 178)

Safety swing seat

Art. no. 4712 black (see page 183)

Art. no. 4712-1 Multicoloured, with 2.00 m long chains (see page 183)

Recommended suspension bearings:

Articulated swing hook

Art. no. 4602 (see page 189)

Safety suspension bearing

Art. no. 4607 (see page 189)

Universal joint incl. safety bearings

Art. no. 4608-1 (see page 188)



Arch swing concrete-in version

Art.no. 4580-4

Equipment

- 1 steel swing arch (Ø 140 mm), hot-dip galvanised, special paint (red) included in delivery
- 2 steel posts (Ø 140 mm), hot-dip galvanised, length 3.00 m, special paint (red) included in delivery
- 2 hanging clips with universal joint and safety chain
- 2 buried ground anchors, each with base 1.44 x 0.47 m

Technical data

Suspension height:	2.50 m
Equipment height:	3.10 m
Space requirement:	4.10 x 1.40 m
Safety zone:	2.65 x 8.20 m
Min. fall protection:	22.00 m ²
Height of fall:	2.35 m
Ground surface:	see table on page 275

Caution!
The space required for the equipment foundation (assembly space) is larger than the safety zone.



Arch swing
with buried ground anchors

Art.no. 4580-4B

Our original HUCK birds nest can be found on Page 175!

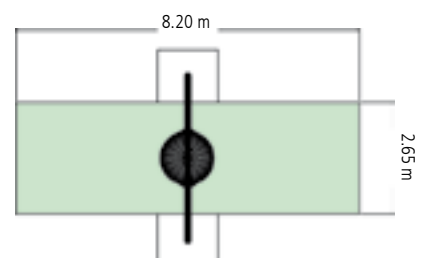



“Junior” swing frame

Art.no. 4580-3-250

Suitable connecting parts can be found on page 175 onwards!

Equipment

4 steel posts (Ø 76 mm), hot-dip galvanised, length 4.00 m, 1 steel head beam (Ø 100 x 100 mm), length 2.55 m, hot-dip galvanised, special paint (red) included in delivery

Without hanging components or bearings

Technical data

Suspension height: 2.50 m

Space requirement: 4.80 x 4.00 m

Safety zone: 4.80 x 8.20 m

Min. fall protection: 39.50 m²

Height of fall for single-seat swings: 1.60 m

for bird's nest: 2.35 m

Ground surface: see table on page 275





Steel long swing frame

Art. no. 4580-2-200 Suspension height 2.00 m
 Art. no. 4580-2-250 Suspension height 2.50 m

Equipment

4 steel posts (Ø 76 mm), hot-dip galvanised, 1 steel head beam (100 x 100 mm), hot-dip galvanised, length 6.00 m, special paint (red) included in delivery
 Without hanging components and suspension bearings

Technical data

Suspension height:	2.00 m	2.50 m
Equipment height:	2.20 m	2.70 m
Space requirement:	6.00 x 4.00 m	6.00 x 4.00 m
Safety zone:	10.00 x 7.30 m	10.00 x 8.20 m
Min. fall protection:	73.00 m ²	82.00 m ²
Height of fall for single-seat swings:	1.40 m	1.60 m
for bird's nest:	2.10 m	2.35 m
for climbing chimney carousel:	1.60 m	2.10 m
Ground surface:	see table on page 275	see table on page 275



Recommended hanging components:

Original HUCK Bird's Nest®

Art. no. 4650 (see page 175)

Climbing chimney carousel with ground anchors

Art. no. 4611 (see page 178)

Safety swing seat

Art. no. 4712 black (see page 183)
 Art. no. 4712-1 Multicoloured, with 2.00 m long chains (see page 183)

Recommended suspension bearings:

Articulated swing hook

Art. no. 4602 (see page 189)

Safety suspension bearing

Art. no. 4607 (see page 189)

Universal joint incl. safety bearings

Art. no. 4608-1 (see page 188)



Mini M-swing

Art. no. 4540-10 Posts with suspension bearings, without hanging components

Art. no. 4540-10-04 Posts with suspension bearings, without hanging components, powder-coated

Equipment

2 steel posts (Ø 102 mm), hot-dip galvanised, length 2.40 m, with caps and suspension bearings, special paint (blue) included in delivery, powder-coated in Gentian Blue (RAL 5010) available for an additional charge

2 swing bearings (art. 4602M)

Technical data

Suspension height: 1.45 m

Space requirement: 2.30 x 0.90 m

Safety zone: 2.30 x 6.30 m

Min. fall protection: 14.50 m²

Height of fall for single-seat swings: 1.60 m

Ground surface: see table on page 275

Caution!

The space required for the equipment foundation (assembly space) is larger than the safety zone.



4540-10 + 4650-85M

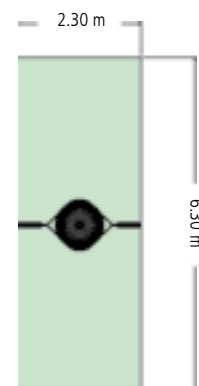

SUPER PRACTICAL!

With buried anchors this play equipment is simple to set up and can be played on immediately!
(page 249)



Recommended hanging components:

Original HUCK mini Bird's Nest®

Art. no. 4650-85M (see page 176)



Toddler swing

Art. no. 4693M (see page 185)





“Midi” easy-swing

Art.no. 4591-50-2

Post equipment

2 steel posts (Ø 102 mm), hot-dip galvanised, length 3.00 m, incl. crossbeam and suspension, special paint (blue) included in delivery

Equipment, hanging component

Armrests in steel tubing wrapped round with rope for padding

Seat made of fabric-reinforced rubber with textile insert

Technical data

Suspension height:	2.00 m
Seat dimensions (w x h x d):	0.55 x 0.90 x 0.60 m
Space requirement:	2.30 x 0.60 m
Safety zone:	2.10 x 7.40 m
Min. fall protection:	15.60 m ²
Height of fall:	1.30 m
Ground surface:	see table on page 275

Caution!

The space required for the equipment foundation (assembly space) is larger than the safety zone.



Also available in the wide seat version, as a “Maxi” Easy Swing upon request!

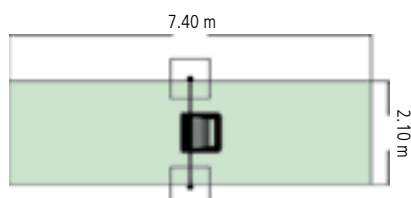

“Maxi” easy-swing

Art.no. 4591-50-1

Seat dimensions (w x h x d):
0,80 m x 1,05 m x 0,80 m

We reserve the right to make technical alterations.



"Swing bed" easy-swing

Art.no. 4591-50-9

Post equipment

4 steel posts (Ø 102 mm), hot-dip galvanised, length 3.00 m, special paint (blue) included in delivery

Equipment, hanging component

Lying surface made of bird's nest chain-link mat, with slightly raised head end

Same padding as on original HUCK Bird's Nest®

4 suspension points, incl. safety chains

Hercules rope for suspension (Ø 16 mm, 6-strand, with steel core)

Technical data

Suspension height: Fully adjustable, max. 2.00 m

Seat dimensions (w x h x d): 1.20 x 0.80 m

Space requirement: 2.40 x 1.80 m

Safety zone: 2.25 x 7.40 m

Min. fall protection: 16.70 m²

Height of fall: 1.25 m

Ground surface: see table on page 275

Caution!

The space required for the equipment foundation (assembly space) is larger than the safety zone.

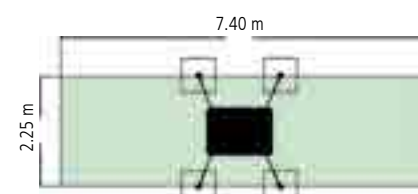



“Honeycomb nest” easy-swing

Art.no. 4591-50-3

Post equipment

2 steel posts (Ø 102 mm), hot-dip galvanised, length 3.00 m, special paint (blue) included in delivery

Equipment, hanging component

1 HUCK honeycomb nest, octagonal, (Ø 1.00 m), with two-point suspension

colourful padded rope ring

Seat made of original HUCK Bird’s Nest®

with safety chains

Hercules rope for suspension
(Ø 16 mm, 6-strand, with steel core)

Technical data

Suspension height: Fully adjustable,
1.40 m - 2.00 m

Seat dimensions
(w x h x d): Ø 1.00 m, octagonal

Space requirement: 2.50 x 1.00 m

Safety zone: 2.30 x 7.40 m

Min. fall protection: 17.00 m²

Height of fall: 2.10 m

Ground surface: see table on page 275

Caution!

The space required for the equipment foundation (assembly space) is larger than the safety zone.

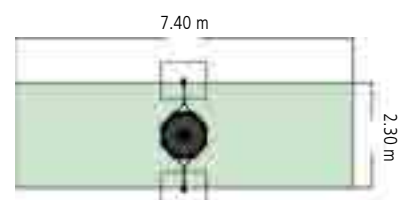



* For durable, long-lasting swinging experience:
All HUCK nest swings now come with completely reworked and extra strong anti abrasion protection on the connections of the suspension chains to the nest and on the suspension-chain cross points!

Original HUCK Bird's Nest®

Art.no. 4650

Equipment

Two-point suspension

Colourful rope ring (Ø 1.20 m), padded, standard colour blue or green (also available in red, black or hemp on request)

Seat made of steel-rope chain-link mat

Suspension chains with rubber-fabric tubing (red), with Hercules rope on request

Delivered without suspension bearings (we recommend universal joint, art. no. 4608-1)

Suspension height 2.00 m or 2.50 m or as universal suspension up to a suspension height of 2.00 m to 2.50 m (please specify at time of order)

Technical data

Suspension height:	2.00 m	2.50 m
Diameter:	approx. 1.20 m	approx. 1.20 m
Bore spacing:	1.90 m	1.90 m
Min. distance to swing frame:	0.70 m	0.70 m
Height of fall:	2.10 m	2.35 m
Ground surface:	see table on page 275	see table on page 275



Exceeds all safety requirements of EN 1176-2: extra strong padding, entrapment-protected linked mat

Additional information on the original HUCK birds nest can be found on page 13!



Original HUCK mini Bird's Nest®

Art. no. 4650-85

Equipment

Two-point suspension

Colourful rope ring (Ø 0.90 m), padded, same rope colours as for art. 4650

Seat made of steel-rope chain-link mat

Suspension chains with rubber-fabric tubing (red), with Hercules rope on request

Delivered without suspension bearings (we recommend universal joint, art. no. 4608-1)

Suspension height 2.00 m or 2.50 m or as universal suspension up to a suspension height of 2.00 m to 2.50 m (please specify at time of order)

Technical data

Suspension height:	2.00 m	2.50 m
Diameter:	approx. 0.90 m, round	approx. 0.90 m, round
Bore spacing:	1.54 m	1.54 m
Min. distance to swing frame:	0.70 m	0.70 m
Height of fall:	2.00 m	2.25 m
Ground surface:	see table on page 275	see table on page 275



Original HUCK honeycomb nest

Art. no. 4550

Equipment

Two-point suspension

Colourful rope ring (Ø 1.00 m), octagonal, padded, same rope colours as for art. 4650

Seat made of steel-rope chain-link mat

Suspension chains with rubber-fabric tubing (red), with Hercules rope on request

Delivered without suspension bearings (we recommend universal joint, art. no. 4608-1)

Suspension height 2.00 m or 2.50 m or as universal suspension up to a suspension height of 2.00 m to 2.50 m (please specify at time of order)

Technical data

Suspension height:	2.00 m	2.50 m
Diameter:	approx. 1.00 m, octagonal	approx. 1.00 m, octagonal
Bore spacing:	1.54 m	1.54 m
Min. distance to swing frame:	0.70 m	0.70 m
Height of fall:	2.00 m	2.25 m
Ground surface:	see table on page 275	see table on page 275



Universal joint incl. safety bearings

Art. no. 4608-1

Equipment

For suspension of heavy swings (e.g. original HUCK Bird's Nest®)

with PA bearings and additional Teflon bush

Bolts, universal joint M18 x 220 mm, bolts, safety bearing M16 x 200 mm

with additional safety bearings and chain, specially designed for suspension of the original HUCK Bird's Nest®

Order quantity per swing seat: 2 units

The maintenance and repair solution:



Nest base repair set

Art.no. 4650-30



Equipment

PA-coated steel cable, 3/4.5 mm, 5 running metres

30 plastic chain links (20 wide, 10 small)

10 VA screw connectors

20 torx screws, M5 x 10 mm

1 set of instructions

Wrapping rope repair set

Art.no. 4650-31



Equipment

1 shrink ring, self-adhesive, black, width 50 mm incl. adhesive patch, 0.40 running metres.

1 shrink ring, self-adhesive, black, width 75 mm incl. adhesive patch, 0.40 running metres.

1 roll fabric tape, 19 mm wide, white, 55 running metres.

2 tube clamp (Ø 90-110 mm)

1 set of instructions



Climbing chimney (without ground anchors)

Art.no. 4610

Equipment

- 2 rope rings (Ø 65 mm)
- Acacia wood rungs
- Including rotating swivel (art. no. 4608-2)
- Connections made of Hercules rope (Ø 16 mm, 6-strand, with steel core)

Climbing chimney carousel (with ground anchors)

Art.no. 4611

Equipment

- 2 rope rings (Ø 65 mm)
- Acacia wood rungs
- Including rotating swivel (art. no. 4608-2)
- Connections made of Hercules rope (Ø 16 mm, 6-strand, with steel core)

Technical data

Suspension height:	2.00 m or 2.50 m
Diameter:	approx. 0.70 m
Minimum distance from furthest point of equipment to the next fixed construction part:	0.70 m (climbing chimney carousel) 1.00 m (climbing chimney)
Ground surface:	see table on page 275



Rope ring swing carousel

Art.no. 4620

Equipment

- 3 rope rings (Ø 65 mm)
- Connecting chains
- Including rotating swivel (art. no. 4608-2)

Technical data

Suspension height:	2.00 m or 2.50 m
Equipment Diameter:	approx. 0.70 m
Minimum distance from furthest point of equipment to the next fixed construction part:	1.00 m
Ground surface:	see table on page 275





Oval rope-ring swing

Art.no. 4630

Equipment

Waterproof bonded base board

2 oval, colourful rope rings (Ø 65 mm), padded (illustration without padding)
incl. articulated swing hooks (art. no. 4602) with 16 mm suspension bolts

Technical data

Suspension height:	2.00 m or 2.50 m
Dimensions:	approx. 0.60 x 1.05 m
Suspension chains:	with sleeve
Bore spacing:	0.70 m
Minimum distance from furthest point of equipment to the next fixed construction part:	0.60 m
Ground surface:	see table on page 275



Jungle rope swing

Art.no. 4770-08-200 Suspension height 2.00 m

Art.no. 4770-08-250 Suspension height 2.50 m

Equipment

Stable, weatherised PP rope (Ø 90 mm)

Without suspension bearings (we recommend art. no. 4602) or frame

Technical data

Suspension height:	2.00 m	2.50 m
Rope thickness:	90/90 mm	90/90 mm
Bore spacing:	2.00 m	2.00 m
Min. distance to swing frame:	0.70 m	0.70 m
Height of fall:	1.25 m	1.50 m
Ground surface:	see table on page 275	see table on page 275





Rustic duo swing

Art.no. 4771-08

Equipment

Square-plaited PP rope serves as seating surface, indiv. seat area: 14 x 50 cm, total length: 1.30 m

Suspension chains with tubing, suspension height: 2.00 m or 2.50 m (please specify) (we recommend suspension bearings art. no. 4602)

Technical data

Suspension height:	2.00 m	2.50 m
Seat:	140/140 mm	140/140 mm
Bore spacing:	2.00 x 0.60 m	2.00 x 0.60 m
Min. distance to swing frame:	0.60 m	0.60 m
Height of fall:	1.25 m	1.50 m
Ground surface:	see table on page 275	see table on page 275



Rustic trio swing

Art.no. 4772-08

Equipment

Square-plaited PP rope serves as seating surface, indiv. seat area: 14 x 50 cm, total length: 1.80 m

Suspension chains with tubing, suspension height: 2.00 m or 2.50 m (please specify) (we recommend suspension bearings art. no. 4602)

Technical data

Suspension height:	2.00 m	2.50 m
Seat:	140/140 mm	140/140 mm
Bore spacing:	3.00 x 0.55 m	3.00 x 0.55 m
Min. distance to swing frame:	0,60 m	0.60 m
Height of fall:	1.25 m	1.50 m
Ground surface:	see table on page 275	see table on page 275





Rope-end swing

Art.no. 4585-40

Equipment

Seating made from 4-sided, plaited PP rope (Ø 160 mm)

Delivered without suspension bearings (we recommend art. no. 4608)

Ropes made from Hercules rope (Ø 16 mm, 6-strand, with steel core)

Technical data

Suspension height:	2.00 m	2.50 m
Seat:	3 x 50 x 14 cm	3 x 50 x 14 cm
Bore spacing:	1.90 m	1.90 m
Min. distance to swing frame:	0.90 m	0.90 m
Height of fall:	1.30 m	1.55 m
Ground surface:	see table on page 275	see table on page 275



Additional group swings can be found in the "Group swing, hammock + aerial runway" chapter - page 192 onwards!





Toddler partner swing 2-seat

Art.no. 4693-40-1

Equipment

2 toddler swing seats (art. 4693), adjacent, with suspension ropes and adjustable chain

(we recommend suspension bearings art. no. 4602)

Suspension heights: 2.00 – 2.50 m

Ropes made from Hercules rope (Ø 16 mm, 6-strand, with steel core)



Toddler group swing 4-seat

Art.no. 4693-40-4

Equipment

4 toddler swing seats (art. 4693), adjacent, with suspension ropes and adjustable chain

(we recommend suspension bearings art. no. 4602)

Suspension heights: 2.00 – 2.50 m

Ropes made from Hercules rope (Ø 16 mm, 6-strand, with steel core)





4712

Safety swing seat

Art. no. 4712 Black, with 2.00 m long chains

Art. no. 4712-1 Multicoloured, with 2.00 m long chains

Art. no. 471 Black, without chains

Art. no. 471-1 Multicoloured, without chains

Equipment

Aluminium core in the seat for high flexural strength

Chain and seat connected by means of a stainless steel shackle

Dimensions: 35 x 15 cm

Colour: black or multicoloured



4712-1

Chain fittings for safety swing seats

Art. no. 4750 2 chains for 1 swing seat

Art. no. 4750-00 for every additional running meter

Equipment

Chain diameter Ø 6 mm, chain length 2.00 m, galvanised as per DIN 766

Stainless steel shackle (6 mm) at the end

1 pair per seat, suitable for safety swing seats



5720-1

Swing seat

Art. no. 5720-1 Black, with 2.00 m long chains and safety link no. 5

Equipment

Seat made of high density polyethylene (HDPE), cut-resistant, flame-resistant, light, very stable and designed for the public domain, chain length 2.20 m.

Dimensions: 35 x 15 cm



4700

Rustic board swing

Art. no. 4700-08

Equipment

Seat board made of oak, elaborate finish, screwed-on cross members

Suspension height adjustable (2.00 m to 2.50 m)

Suspension ropes PP-multifil (Ø 14 mm), hemp

for the private domain



Tyre swing with net base

Art.no. 4698

Equipment

Net base (Ø 60 cm) made of Hercules rope (Ø 16 mm, 6-strand, with steel core)

Recommended suspension bearings art. no. 4602

Suspension height 2.00 m or 2.50 m



Simple tyre swing

Art.no. 4698-1

Equipment

Tyre swing (Ø 60 cm), with suspension chains in tubing

Recommended suspension bearings art. no. 4602

Suspension height 2.00 m or 2.50 m



Dish swing

Art.no. 4691

Equipment

Steel ring (Ø 27 mm), wound round with rope

Phenolic plywood seating surface (Ø 66 cm), with suspension ropes made of Hercules rope (Ø 16 mm, 6-strand, with steel core)

Including articulated swing hook with stainless steel shackle (art. 4602)

Suspension height 2.00 m or 2.50 m



Pendulum seat

Art. n o . 491 With chain and rotating swivel

Art. n o . 490 Without chain and rotating swivel, adapter to suit 6 mm chain

Equipment

Seating surface with stable steel core (Ø 25 cm)

Suspension chain (approx. 2.00 m) with high-quality fabric-reinforced rubber tubing with stainless steel rotating swivel (art. no. 4603)

Suspension height 2.00 m or 2.50 m





Toddler swing

Art. no. 4693

Equipment

Seat made of firm rubber material (36 x 32 cm)

Hanging rope made from Hercules rope
(Ø 16 mm, 6-strand, with steel core)

Adjustable chain and articulated swing hook with stainless steel shackle (art. no. 4602)

Suspension height 2.00 m or 2.50 m



Baby seat

Art. no. 4693-10

Equipment

Ropes made from Hercules rope (Ø 16 mm, 6-strand, with steel core)

High belt edge (Ø 35 cm)

With adjustable chain and stainless steel shackle
(we recommend suspension bearings art. no. 4602)

Suspension height: 2.00 m



Baby cradle

Art. no. 4693-50

Equipment

Ropes made from Hercules rope (Ø 16 mm, 6-strand, with steel core)

Dimensions 65 x 35 cm

Without adjustable chain, articulated swing hook and stainless steel shackle (we recommend suspension bearings art. no. 4602)

Suspension height: 2.00 m





Maxi swing for those of limited mobility

Art.no. 4695

Equipment

Including articulated swing hook with stainless steel shackle (art. no. 4602)

Technical data

Suspension height:	2.00 m / 2.50 m (please specify)
Width x height x depth:	0.80 x 1.05 x 0.80 m
Bore spacing:	0.80 m
Minimum distance from furthest point of equipment to the next fixed construction part:	0.70 m
Seat:	rubber (green) with textile insert
Armrests:	Steel tube, with rope padding (blue)



Midi swing for those of limited mobility

Art.no. 4695-30

Equipment

Including articulated swing hook with stainless steel shackle (art. no. 4602)

Technical data

Suspension height:	2.00 m / 2.50 m (please specify)
Width x height x depth:	0.60 x 0.90 x 0.60 m
Bore spacing:	0.55 m / 0.60 m
Minimum distance from furthest point of equipment to the next fixed construction part:	0.65 m
Seat:	rubber (green) with textile insert
Armrests:	Steel tube, with rope padding (blue)



Mini swing for those of limited mobility

Art.no. 4696

Equipment

Including articulated swing hook with stainless steel shackle (art. no. 4602)

Technical data

Suspension height:	2.00 m / 2.50 m (please specify)
Width x height x depth:	0.60 x 0.30 x 1.20 m
Bore spacing:	0.55 m / 0.60 m
Minimum distance from furthest point of equipment to the next fixed construction part:	0.65 m
Seat:	rubber (green) with textile insert
Armrests:	Steel tube, with rope padding (blue)





Q Easy-Swing "Swing bed"
(page 173)

Swing bed

Art.no. 4651-20

Equipment

Lying surface made of synthetic woven mat (1.50 x 1.00 m), slightly raised top end, narrow sides padded

4 suspension points, suspension ropes made of Hercules rope (Ø 16 mm, 6-strand, with steel core)

Suspension height 2.00 m to 2.50 m





M8 shackle rotating swivel

Art.no. 4603 Without ball bearing, stainless steel



Rotating swivel

Art.no. 4606

Equipment

Ball bearing for 8 mm chains

Load 150 kg, aluminium, maintenance-free



Universal joint with rotating swivel

Art.no. 4608-2

Equipment

Entirely in stainless steel

Bolts M16 x 200, with maintenance-free ball bearing



Swing bearings with bolts

Art.no. 4608-4

Equipment

Bolts M16 x 200 mm, galvanised, red powder-coated

with M8 stainless steel shackle and M8 stainless steel rotating swivel with fork head



Safety suspension bearing

Art.no. 4607

Equipment

Bolts M12 x 200 mm, galvanised

With stainless steel rotating swivel (art. no. 4603), maintenance-free



Articulated swing hook

Art.no. 4602

Equipment

Bolts M12 x 200 mm, galvanised

With PA bush with M8 stainless steel shackle, for steel and wood



Articulated swing hook strengthened design

Art.no. 4608-3

Equipment

Bolts M16 x 200

With PA bearings and Teflon bush

Designed to swing in one direction

Safety bearings for art. 4608-1



Universal joint

Art.no. 4608

Equipment

Bolts M18 x 200 mm

with PA bearings and additional Teflon bush



Tried and tested for ten years and safe in use!



Universal joint incl. safety bearings

Art.no. 4608-1

Equipment

with PA bearings and additional Teflon bush

Bolts, universal joint M18 x 220 mm, bolts, safety bearing M16 x 200 mm

With additional safety bearings and chain, specially designed for suspension of the original HUCK Bird's Nest®



Tried and tested for ten years and safe in use!



Safety bearing and chain

Art.no. 4608-5

Equipment

Bolts M16 x 200 mm, galvanised, red powder-coated

with PA sleeve, 2 M8 stainless steel shackles, safety chain no. 8, for wood and steel



Suspension bearing for mini M-swing

Art.no. 4602 M

Equipment

Bolts M12 x 200 mm, galvanised, red powder-coated

with M8 stainless steel shackle and M8 stainless steel rotating swivel

Bearings galvanised, powder coated or 100% stainless steel.

Bearings in polyamide or with inside plain bearing bush made from Teflon coated brass.

All bearings with stop nuts, washers and caps.

Group Swings, Hammocks & Aerial Runways – where the “us” factor is everything

We all know everything’s more fun when shared with friends. That’s why HUCK has a whole host of group swings for kids to let off steam together. All our swings endorse the “us” factor and teamwork among children. The only way to get the swings into the right momentum is by moving in time in the same direction. Another attraction in the “extra” class are the HUCK aerial runways. Seated on a comfortable button seat, youngsters can zoom right across the playground with the wind in their hair. And if the children are worn out after a ride on the aerial runway, they can hang out and relax on a HUCK hammock. Whether energetic or laid-back, you are bound to get your money’s worth here!

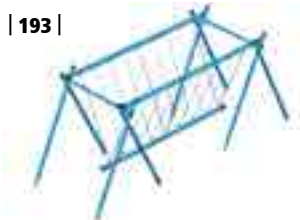

| 193 |

Viking super rope-end swinger



| 195 |

Dragon rope-end swinger



| 196 |

Victory rope-end swinger

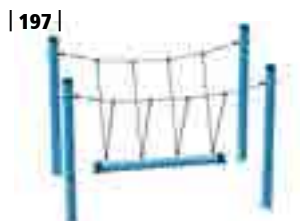

| 197 |

Gondolar rope-end swinger



| 198 |

Cyclops rope-end swinger,
4-seater, single



| 199 |

Hydra rope-end swinger,
4-seater, double

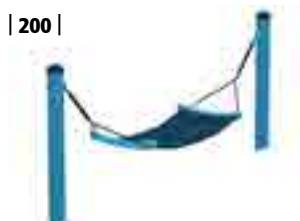

| 200 |

Hammocks

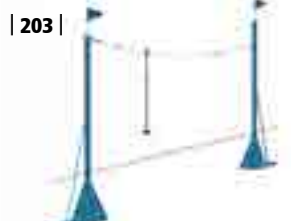

| 203 |

Aerial runway



Viking super rope-end swinger

Art. n.º 4 5 8 5 - 6 0 European design patent

Equipment

Douglas fir posts (Ø 160 mm) with post shoes

Seating made from 4-sided, plaited PP rope (Ø 160 mm)

8 seats for up to 12 children

Ropes made from Hercules rope (Ø 16 mm, 6-strand, with steel core)

Technical data

Equipment height: 3.70 m

Space requirement: 10.70 x 4.05 m

Safety zone: 14.10 x 4.05 m

Min. fall protection: 57.15 m²

Height of fall: 1.50 m

Ground surface: see table on page 275

Caution!

The space required for the equipment foundation (assembly space) is larger than the safety zone.

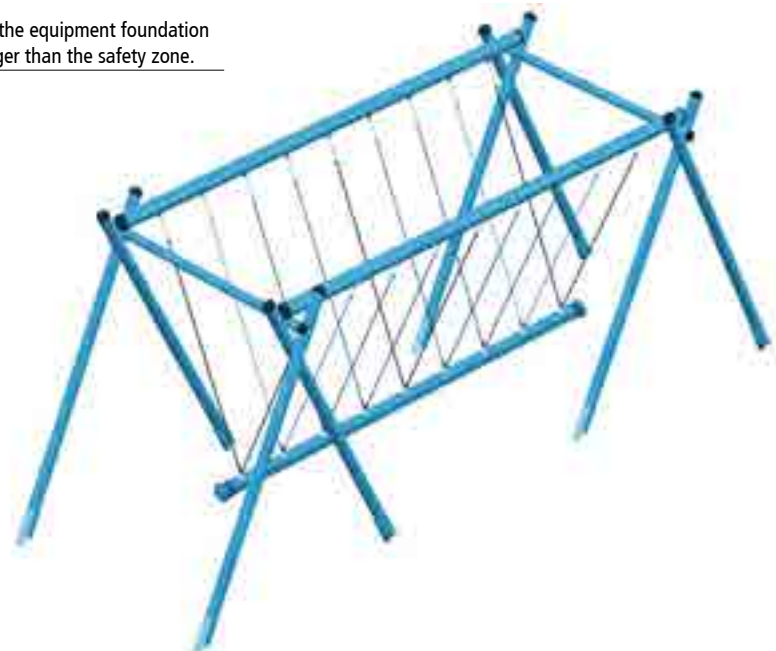
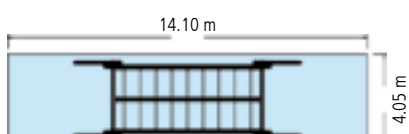





Dragon rope-end swinger

Art. no. 4585-10

Equipment

Posts made from waterproofed pine (Ø 160 mm), base posts with post shoes

Seating made from 4-sided, plaited PP rope (Ø 160 mm)

11 seats for 15 children

Ropes made from Hercules rope (Ø 16 mm, 6-strand, with steel core)

Technical data

Equipment height: 5.30 m

Space requirement: 17.50 x 8.90 m

Safety zone: 17.50 x 8.90 m

Min. fall protection: 155.75 m²

Height of fall: 1.50 m

Ground surface: see table on page 275

Caution!

The space required for the equipment foundation (assembly space) is larger than the safety zone.

THE PIECE OF EQUIPMENT FOR THE BIGGEST STAMPEDE!
 Successful in schools, parks etc. for years.

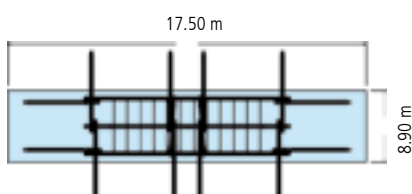

We reserve the right to make technical alterations.





Victory rope-end swinger

Art. no. 4585-50

Equipment

Steel pipe design, hot-dip galvanised, special paint (red) included in delivery

Seating made from 4-sided, plaited PP rope (Ø 160 mm)

8 seats for around 12 children

Ropes made from Hercules rope (Ø 16 mm, 6-strand, with steel core)

Technical data

Equipment height: 3.20 m

Space requirement: 5.50 x 8.60 m

Safety zone: 5.50 x 12.75 m

Min. fall protection: 70.50 m²

Height of fall: 1.50 m

Ground surface: see table on page 275

Caution!

The space required for the equipment foundation (assembly space) is larger than the safety zone.

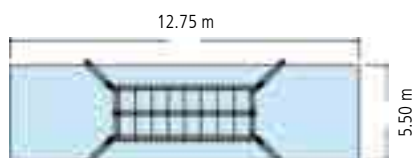



Gondolar rope-end swinger

Art. n.º. 4585S Steel posts (Ø 102 mm)

Art. n.º. 4585PS Douglas fir posts (Ø 180 mm), with post shoes

Equipment

Standard version: Douglas fir posts (Ø 180 mm), length 3.70 m, with specially-made galvanised post shoes and plastic caps

Maintenance-free hanging fittings

Seating made from 4-sided, plaited PP rope (Ø 160 mm)

Ropes made from Hercules rope (Ø 16 mm, 6-strand, with steel core), colours: blue, red, yellow, green

Technical data

Equipment height:	2.70 m
Space requirement:	2.20 x 3.70 m
Safety zone:	2.80 x 7.60 m
Min. fall protection:	21.50 m ²
Height of fall:	1.50 m
Ground surface:	see table on page 275



Equipment here shows Douglas fir posts

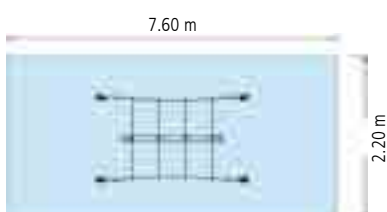



Image shows double version
(Art. no. 4585-MDD4)

Cyclops rope-end swinger 4-seater, single

Art. no. 4585-MD4

Equipment

4 steel posts (Ø 102 mm), hot-dip galvanised, length 3.60 m, special paint (blue or red) included in delivery

2 steel cross beams (Ø 102 mm), hot-dip galvanised, length 4.15 m, special paint (blue or red) included in delivery

1 swing rope from 4-sided, plaited PP rope (Ø 160 mm)

10 hanging ropes with fittings (Art. no. 4602)

Ropes made from Hercules rope (Ø 16 mm, 6-strand, with steel core)

Technical data

Equipment height:	2.65 m
Space requirement:	5.25 x 2.10 m
Safety zone:	8.00 x 3.00 m
Min. fall protection:	24.00 m ²
Height of fall:	1.50 m
Ground surface:	see table on page 275



Other designs with 3 or 5 seats on request!

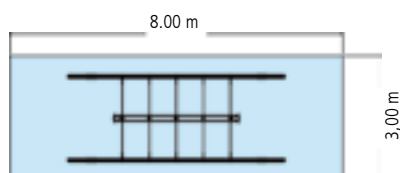



Hydra rope end swinger 4-seater, double

Art. no. 4585-MDD4

Other designs with 3 or 5 seats on request!

Equipment

6 steel posts (Ø 102 mm), hot-dip galvanised, length 3.60 m, special paint (blue or red) included in delivery

3 steel cross beams (Ø 102 mm), hot-dip galvanised, length 4.15 m, special paint (blue or red) included in delivery

2 swing ropes made from 4-sided, plaited PP rope (Ø 160 mm)

15 hanging ropes with fittings (Art. no. 4602)

Ropes made from Hercules rope (Ø 16 mm, 6-strand, with steel core)

Technical data

Equipment height:	2.65 m
Space requirement:	5.25 x 4.10 m
Safety zone:	8.00 x 5.10 m
Min. fall protection:	40.80 m ²
Height of fall:	1.50 m
Ground surface:	see table on page 275

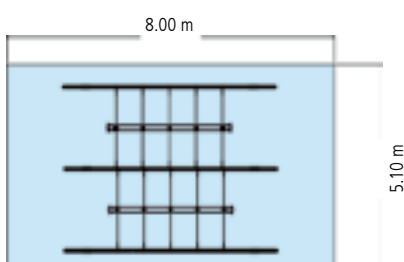



Steel link-rope hammock

Art. no. 806

Equipment

Lying surface made from specially-made links with steel rope insert, hanging fittings and posts not included

Suspension ropes made from Hercules rope (Ø 16 mm, 6-strand, with steel core), incl. length-adjusting chains

Technical data

Lying surface:	0.80 x 1.86 m
Equipment height:	1.70 m
Space requirement:	4.80 x 0.80 m
Safety zone:	4.80 x 4.00 m
Min. fall protection:	19.20 m ²
Height of fall:	1.00 m
Ground surface:	see table on page 275



Posts for hammocks incl. suspension bearings

Art. no. 805 Oak (Ø 160 mm), length 2.50 m, with safety steel straps

Art. no. 805 S Steel (Ø 102 mm), length 2.50 m

Art. no. 805 PS Douglas fir (Ø 180 mm), length 2.70 m, with post shoes (each suspended at a height of 1.50 m)



Rubber hammock

Art. no. 807

Equipment

Lying surface made from fabric-covered PVC-coated belt, suspension bearings and posts not included

Hanging rope made from Hercules rope (Ø 16 mm, 6-strand, with steel core)

Length-adjusting chains

Technical data

Lying surface:	0.80 x 1.95 m
Equipment height:	1.70 m
Space requirement:	4.80 x 0.80 m
Safety zone:	4.80 x 4.00 m
Min. fall protection:	19.20 m ²
Height of fall:	1.00 m
Ground surface:	see table on page 275

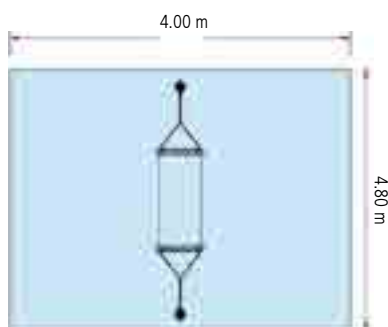



Hercules rope hammock

Art. no. 808

Equipment

Lying surface and hanging ropes made from Hercules rope (Ø 16 mm, 6-strand, with steel core), incl. length-adjusting chains
suspension bearings and posts not included

Technical data

Equipment height:	1.70 m
Space requirement:	4.80 x 0.80 m
Safety zone:	4.80 x 4.00 m
Min. fall protection:	19.20 m ²
Height of fall:	1.00 m
Ground surface:	see table on page 275



Hercules rope hammocks with plastic knot clips

Art. no. 808VA

Equipment

Bed and Hercules suspension rope (Ø 16mm, 6-strand, with steel core), incl. length adjusting chains
without hanging fittings and posts

Technical data

Equipment height:	1.70 m
Space requirement:	4.80 x 0.80 m
Safety zone:	4.80 x 4.00 m
Min. fall protection:	19.20 m ²
Height of fall:	1.00 m
Ground surface:	see table on page 275



Polyester hammock

Art. no. 807-200

Equipment

Lying surface made from high-quality, weather-proof, water-permeable, extra-strong polyester weave (0.60 x 1.60 m)
Hanging rope made from Hercules rope (Ø 16 mm, 6-strand, with steel core)

Technical data

Equipment height:	1.30 m
Space requirement:	3.80 x 0.80 m
Safety zone:	3.80 x 3.80 m
Min. fall protection:	14.50 m ²
Height of fall:	1.00 m
Ground surface:	see table on page 275



Steel posts for polyester hammock

Art. no. 805-200

Equipment

Steel posts (Ø 102 mm), length 2.00 m, with caps and fabric-reinforcement, special paint (red) included in delivery
Incl. suspension bearings



XXL Rest hammock made from Hercules rope

Art. no. 808-1

Equipment
Bed (1.40 x 2.00m) and Hercules suspension rope (Ø 16 mm, 6-strand with steel core)
Without suspension bearings and posts
Incl. length adjusting chain
With anti-roll protection

Technical data	
Lying surface:	2.00 x 1.40 m
Equipment height:	1.70 m
Space requirement:	4.32 x 1.60 m
Safety zone:	4.95 x 4.60 m
Min. fall protection:	21.00 m ²
Height of fall:	1.00 m
Ground surface:	see table on page 275



Posts for XXL Rest hammock, including hanging fittings

Art. no. 805-1S Steel (Ø 159 mm), length 2,50 m

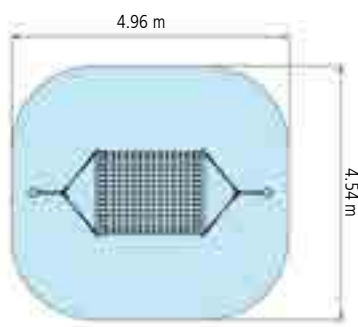

The newly developed pulley hammock gives people with disabilities e.g. wheel-chair users and able-bodied people the opportunity to swing themselves using the pulley and rope.

The design consists of two mounting posts, a crossbeam and a tension post.

Also perfect for Kindergarten use, since the teacher can lay with the children in the hammock. (Bed: 140 x 200cm)



Wet and frequent use of favourite play equipment leads to quick erosion of the turf, thus making the fall protection subsurface look shabby and possible risk of accident.

Lawn protection mats prevent this effectively! Please take a look at our wide range of lawn protection mats on page 247.

We are also happy to offer you the individual elements for this article (e.g. aerial runway carts, pendulum seats)

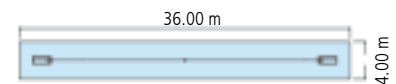

Aerial runway dig-in version

Art. no. 4581

Equipment

Steel supports (Ø 160 mm), hot-dip galvanised
height approx. 3.50 m above level
Dig-in ground anchor (1.20 x 2.00 m)
Tension rope length approx. 30.00 m
(other lengths available on request)
Runner: Stainless steel with brake

Technical data

Maximum gradient: 0.60 m auf 30 m
Equipment height: 3.50 m
Space requirement: 1.00 x 33.10 m
Safety zone: 4.00 x 36.00 m
Fall protection: 144.00 m²
Height of fall: 1.50 m
Ground surface: see table on page 275



Aerial runway set in concrete

Art. no. 4581B

Equipment

Steel supports (Ø 160 mm), hot-dip galvanised
Tension rope length approx. 30.00 m
(other lengths available on request)
Runner: Stainless steel with brake

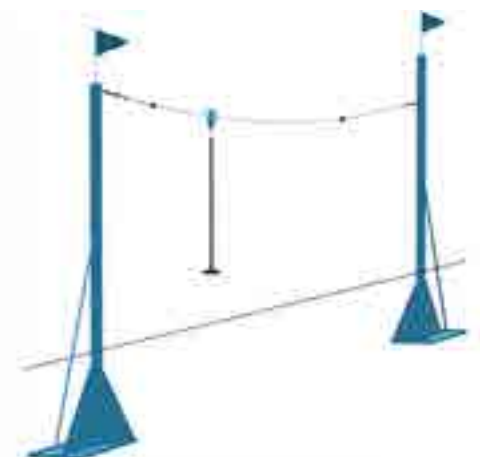

Top edge
Play level

Obstacle-free rope-play equipment – A special kind of freedom

Being active is good for you – and that goes especially for children, youngsters, and adults with limited mobility. HUCK offers a colourful range of obstacle-free play equipment perfectly designed for this target group, such as swings with safety seats, hammocks and trampolines. This HUCK series of equipment offers endless swinging and climbing fun, without over-exerting its users. The swings’ large flat and upright seats invite people to get moving. The climbing equipment is low enough for children to enjoy climbing regardless of their mobility level. The fittings on the all-in-one equipment are of exceptionally high quality. The climbing nets are made from HUCK Hercules rope (Ø 16 mm, 6-strand, with steel core). Our steel posts come with a 15-year guarantee against rust erosion. The equipment is easy to set up with a twist of the hand – no need for any large tools. The comparatively small sized frames mean you can even set up the equipment in smaller play areas.



| 205 |
"Midi" easy-swing



| 206 |
Swing for those of limited mobility
maxi, midi, mini



| 207 |
"Swing bed" easy-swing



| 208 |
Swing bed



| 209 |
Polyester hammock



| 210 |
XXL hammock



| 211 |
Swinging honeycomb nest



| 212 |
Eagle carousel



| 212 |
Spring-mounted Eagle's Nest



| 212 |
Spring-mounted
original HUCK Bird's Nest®



| 213 |
Wheelchair Trampoline "Rolli"



"Midi" easy-swing

Art. no. 4591-50-2

Post equipment

2 steel posts (Ø 102 mm), hot-dip galvanised, length 3.00 m, incl. crossbeam and suspension, special paint (blue) included in delivery

Equipment, hanging component

Armrests in steel tubing wrapped round with rope for padding

Seat made of fabric-reinforced rubber with textile insert

Technical data

Suspension height:	2.00 m
Seat dimensions (w x h x d):	0.55 x 0.90 x 0.60 m
Space requirement:	2.30 x 0.60 m
Safety zone:	2.10 x 7.40 m
Min. fall protection:	15.60 m ²
Height of fall:	1.30 m
Ground surface:	see table on page 275

Caution!

The space required for the equipment foundation (assembly space) is larger than the safety zone.



Also available in the wide seat version, as a "Maxi" Easy Swing, upon request!

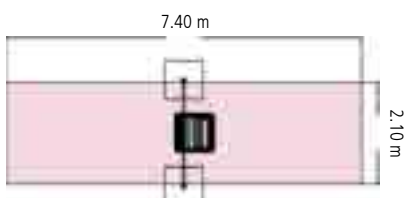

"Maxi" easy-swing

Art. no. 4591-50-1

Seat dimensions (w x h x d):
0,80 m x 1,05 m 0,80 m



Maxi swing for those of limited mobility

Art. no. 4695

Equipment

Including articulated swing hook with stainless steel shackle (art. no. 4602)

Technical data

Suspension height:	2.00 m / 2.50 m (please specify)
Width x height x depth:	0.80 x 1.05 x 0.80 m
Bore spacing:	0.80 m
Minimum distance from furthest point of equipment to the next fixed construction part:	0.70 m
Seat:	rubber (green) with textile insert
Armrests:	Steel tube, with rope padding (blue)



Midi swing for those of limited mobility

Art. no. 4695-30

Equipment

Including articulated swing hook with stainless steel shackle (art. no. 4602)

Technical data

Suspension height:	2.00 m / 2.50 m (please specify)
Width x height x depth:	0.60 x 0.90 x 0.60 m
Bore spacing:	0.55 m / 0.60 m
Minimum distance from furthest point of equipment to the next fixed construction part:	0.65 m
Seat:	rubber (green) with textile insert
Armrests:	Steel tube, with rope padding (blue)



Mini swing for those of limited mobility

Art. no. 4696

Equipment

Including articulated swing hook with stainless steel shackle (art. no. 4602)

Technical data

Suspension height:	2.00 m / 2.50 m (please specify)
Width x height x depth:	0.60 x 0.30 x 1.20 m
Bore spacing:	0.55 m / 0.60 m
Minimum distance from furthest point of equipment to the next fixed construction part:	0.65 m
Seat:	rubber (green) with textile insert
Armrests:	Steel tube, with rope padding (blue)





"Swing bed" easy-swing

Art. no. 4591-50-9

Post equipment

4 steel posts (Ø 102 mm), hot-dip galvanised, length 3.00 m, special paint (blue) included in delivery

Equipment, hanging component

Lying surface made of bird's nest chain-link mat, with slightly raised head end

Same padding as on original HUCK Bird's Nest®

4 suspension points, incl. safety chains

Hercules rope for suspension
(Ø 16 mm, 6-strand, with steel core)

Technical data

Suspension height:	Fully adjustable, max. 2.00 m
Seat:	1.20 x 0.80 m
Space requirement:	2.40 x 1.80 m
Safety zone:	2.25 x 7.40 m
Min. fall protection:	16.70 m ²
Height of fall:	1.25 m
Ground surface:	see table on page 275

Caution!

The space required for the equipment foundation (assembly space) is larger than the safety zone.

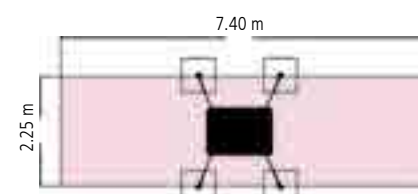



Q Easy Swing "Swing bed"
(page 207)

Swing bed

Art. no. 4651-20

Equipment

Lying surface made of synthetic woven mat (1.50 x 1.00 m), slightly raised top end, narrow sides padded

4 suspension points, suspension ropes made of Hercules rope (Ø 16 mm, 6-strand, with steel core)

Suspension height 2.00 m to 2.50 m





Polyester hammock

Art. no. 807-200

Equipment

Lying surface made from high-quality, weather-proof, water-permeable, extra-strong polyester weave (0.60 x 1.60 m)

Hanging rope made from Hercules rope (Ø 16 mm, 6-strand, with steel core)

Technical data

Equipment height:	1.30 m
Space requirement:	3.80 x 0.80 m
Safety zone:	3.80 x 3.80 m
Min. fall protection:	14.50 m ²
Height of fall:	1.00 m
Ground surface:	see table on page 275



Steel posts for polyester hammock

Art. no. 805-200

Equipment

Steel posts (Ø 102 mm), length 2.00 m, with caps and fabric-reinforcement, special paint (red) included in delivery

Incl. suspension bearings

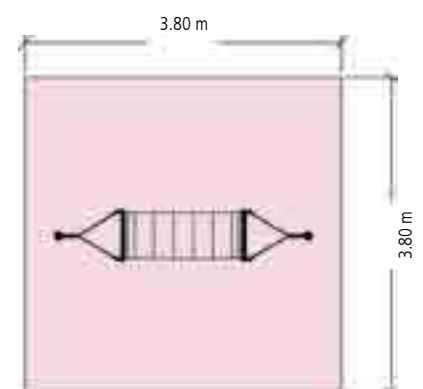



XXL hammock made from Hercules rope

Art. no. 808-1

Equipment
Bed (1.40 x 2.00m) and Hercules suspension rope (ø 16 mm, 6-strand with steel core)
Without suspension bearings and posts
Incl. length adjusting chain
With anti-roll protection

Technical data	
Bed:	2.00 m x 1.40 m
Equipment height:	1.70 m
Space requirement:	4.32 x 1.60 m
Safety zone:	4.95 x 4.60 m
Min. fall protection:	21.00 m ²
Height of fall:	1.00 m
Ground surface:	see table on page 275



Posts for XXL Rest hammock, including hanging fittings

Art. no. 805-1S Steel (Ø 159 mm), length 2,50 m

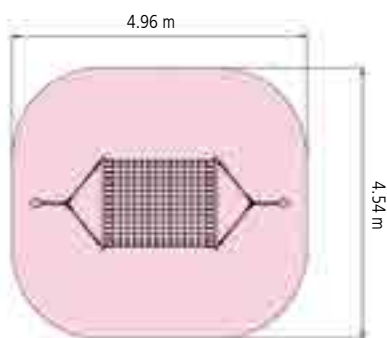

The newly developed pulley hammock gives people with disabilities e.g. wheel-chair users and able-bodied people the opportunity to swing themselves using the pulley and rope.

The design consists of two mounting posts, a crossbeam and a tension post.

Also perfect for Kindergarten use, since the teacher can lay with the children in the hammock. (Bed: 140 x 200cm)



Swinging honeycomb nest

Art. no. 4959-71

Equipment

4 steel posts (Ø 102 mm), hot-dip galvanised, length 2.00 m, with plastic cap, special paint (blue) included in delivery

1 HUCK honeycomb nest (Ø 1.00 m)

4 suspension ropes

Ropes and nets made of Hercules rope (Ø 16 mm, 6-strand, with steel core)

Technical data

Equipment height: 1.30 m

Space requirement: 3.10 x 1.10 m

Safety zone: Ø 4.10 m

Min. fall protection: 13.20 m²

Height of fall: 0.55 m

Ground surface: see table on page 275

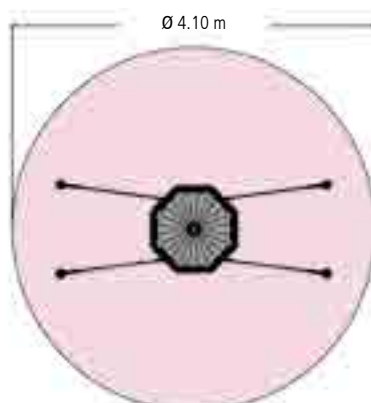



Honeycomb carousel

Art. no. 4668-20 with buried ground anchors

Equipment

- 1 HUCK honeycomb nest (Ø 1.00 m)
- Bars galvanised, painted red
- 1 buried ground anchor, hot-dip galvanised, with pivot bearings

Technical data

Equipment height:	0.45 m
Space requirement:	Ø 1.00 m
Safety zone:	Ø 5.00 m
Min. fall protection:	19.50 m ²
Height of fall:	0.45 m
Ground surface:	see table on page 275



Honeycomb springer

Art. no. 4668-10 with buried ground anchors

Equipment

- 1 HUCK honeycomb nest (Ø 1.00 m)
- Bars galvanised, painted red
- 1 buried ground anchor, hot-dip galvanised, with 1 steel spring (powder-coated)

Technical data

Equipment height:	0.75 m
Space requirement:	Ø 1.00 m
Safety zone:	Ø 4.00 m
Min. fall protection:	12.50 m ²
Height of fall:	0.90 m
Ground surface:	see table on page 275



Birds nest springer

Art. no. 4670 with buried ground anchors

Equipment

- 1 original HUCK Bird's Nest® (Ø 1.20 m)
- Bars galvanised, painted red
- Glulam plate
- 1 buried ground anchor, hot-dip galvanised, with 3 springs

Technical data

Equipment height:	0.85 m
Space requirement:	Ø 1.30 m
Safety zone:	Ø 4.30 m
Min. fall protection:	15.00 m ²
Height of fall:	1.00 m
Ground surface:	see table on page 275



Ø 5.00 m

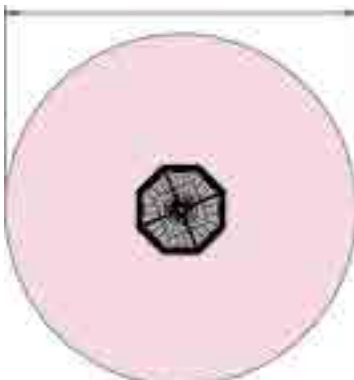

Ø 4.00 m

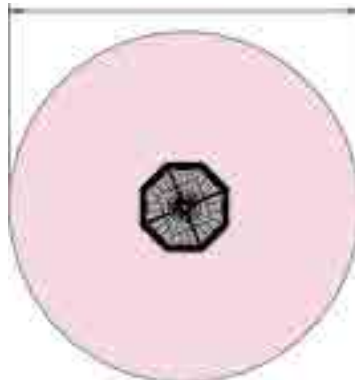

Ø 4.30 m





Wheelchair trampoline "Rolli"

Art. no. 20.02.115

Equipment

Jumping area made from non-slip, vandal-proof mat for medium height jumps

surrounded by fall protection panels (lawn is sufficient outside this area)

Frame can be opened or lifted out

Technical data

Jumping area:	0.90 x 2.50 m
Outer dimensions:	1.40 x 3.00 m
Safety zone:	3,90 x 5,50 m
Min. fall protection:	17.25 m ³
Height of fall:	1.00 m
Ground surface:	see table on page 275



Upon request also in combination with sun protection sails and guy ropes for self-contained examples! (page 227)

Being active is good for you – and that goes equally for people with limited mobility. The trampoline "Rolli" was developed for wheelchair users. The trampoline is inserted in the ground and can be safely and easily accessed thanks to its bevelled edge panels. The flexible trampoline area produces gentle swinging and swaying motions regardless of the weight of a person. As the size is compact, the companion can be in direct contact with the wheelchair user – this is important, for example, for people with severe disabilities.

This picture shows a "Rolli" trampoline with double access ramp on one side (customer requirement)



Recreation, play and sport – a world full of team spirit

Young people need the opportunity to put their strengths to the test in free play and to demonstrate their skills. The challenges of sport also help children and youngsters develop a sense of team spirit. HUCK's range of sports and recreation equipment offers the right materials to suit any requirement. Whether for the playground or sports field, we can give you all the advice you need!

Sports equipment and slam spaces

Prevent deliberate vandalism and go for HUCK's robust and durable sports equipment! Something that may look like a costly investment at first glance, often turns out to be the best value-for-money option. HUCK offers a multitude of vandalism-safe goals, nets and baskets that stand the test of time against intense use.

Enclosed slam spaces are in fashion

But nearby residents often complain about high levels of noise because kids can't resist kicking balls against the high metal fences. The same applies to conventional goals which are made of welded steel grates. These are fairly safe against vandalism but cause a lot of noise. To minimise stress to the neighbours, HUCK offers various solutions. Just as safe from vandalism, but quiet – that's what turns the various types of HUCK nets into a real alternative to those rigid metal fences, as the nets are fitted with a firm steel wire. Goals can also be equipped with these type of nets.

Sun sail and awnings

Protect children from over-exposure to the sun and keep the playground sand clean. Kill two birds with one stone with both the sun sail and awnings from HUCK. Thanks to the HUCK quality, you can keep the protective covers up all year round and hold off the sun, wind or rain depending on the material. Choose your favourites from a multitude of colours, shapes and materials – we'll make you single covers or complete customised solutions with posts. Do your horses need a sun shade? Let us make them one.



Anti-vandalism nets

Vandalised goals are unfortunately not an uncommon sight in public playing fields. Enclosures made from the conventional wire mesh or bar grates increase noise levels though, being far from soundproof. Textile products are ideal for preventing unwanted noise but offer almost no protection from vandalism. HUCK has combined the advantages of both systems and used them as the basis of its 1000x tested rope technology. There are three versions, varying only in the strength of the steel insert, so your planner can choose according to the level of protection you want from vandalism.

Product	Thickness of wire insert	Textile covering	Overall thickness	Mesh stability	Vandalism protection	Noise protection
Mahulan Steel	0.5 mm (strand)	4 mm	4.5 mm	approx. 2.5 kN	x (low)	xxx (high)
Clips net	2.5 mm (wire rope)	2.5 mm	5 mm	approx. 0.5 kN	xx (medium)	xx (medium)
Dralo®	1.5 - 6 mm (wire rope)	without	1.5 - 6 mm	approx. 0.8 - 3.5 kN	xxx (high)	xx (medium)

Clips net

The polypropylene coated, 2.5 mm thick wire rope is bound into a square mesh net using plastic ties. The coating gives it a heavy-duty and attractive surface.
(Pages 216, 222)



Dralo®

Dralo® from the HUCK range is a classically designed wire rope but only extreme levels of violence can damage it. There is also virtually no noise from this rope net when it comes into a contact with a ball.
(Pages 217-218)



„Mahulan Steel“

This new HUCK product is a machine-made protective net with a stainless steel wire core (strand) (DBGM 20 2006 011 018) for consistently high security from vandalism.
(Pages 219-220)





Community play systems

HUCK safety and stop nets are available in all grades of quality!

Multifunctional play areas have an important social function in residential areas. This is where youngsters can be active together and play sports without worrying about breaking windows, for example. Equipped with anti-vandalism sports netting, these systems are high in quality and long-lasting – while improving the quality of life of those nearby.

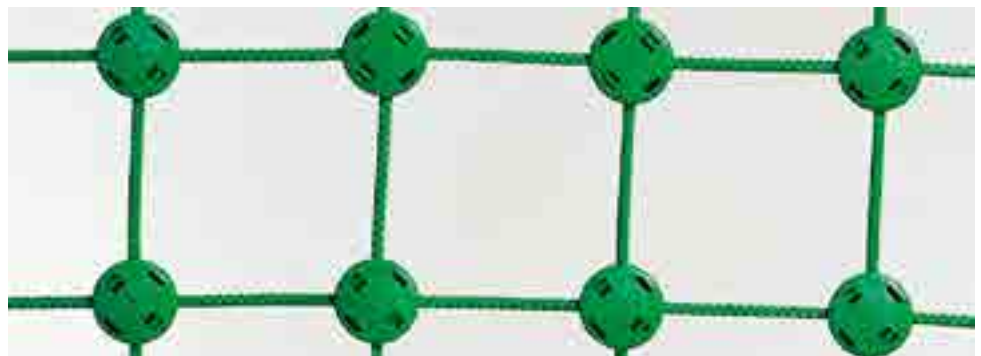

NEW

Now with improved connection and additional scuff protection on the goal frames thanks to high-quality polyamide loops.

As an anti-vandalism ball stop net the HUCK Hercules net is different from steel mesh fences as it is especially sound deadening. (Measured in accordance with EN ISO 11202)!



Ball stop fences made from Dralo® – quiet and safe



HUCKs anti-vandalism nets made from Dralo® have a distinctive contemporary and attractive appearance. These machine-made wire rope nets are formed into square meshing. Despite their robustness they retain their good looks and are soundproof.

Unlike metal fences where the ball bounces off with a smack, the nets give in to the force which significantly reduces noise levels when balls are kicked into the net of football pitches, in residential playgrounds, etc.

Value-for-money mesh composition (50 mm wide), see page 218.



THE ADVANTAGES OF THE NET AT A GLANCE:

- ⊕ Absolutely cut-resistant
- ⊕ Discreet design
- ⊕ Withstands everything but extreme acts of violence
- ⊕ No unwanted noise on ball contact
- ⊕ Comparative value for money

	MS 25 mm	MS 50 mm	MS 75 mm	MS 100 mm	MS 125 mm	MS 150 mm	MS 175 mm	MS 200 mm
Ø 1.5 mm	•	•	•	•	•	•	•	•
Ø 2.0 mm	•	•	•	•	•	•	•	•
Ø 2.5 mm		•	•	•	•	•	•	•
Ø 3.0 mm		•	•	•	•	•	•	•
Ø 4.0 mm		•	•	•	•	•	•	•
Ø 5.0 mm			•	•	•	•	•	•

Cost-effective alternative: rectangular meshes

From the Dralo® net range we recommend our newly developed square mesh designs in sizes e.g. 50 x 100 mm (not including end seams up to a fence height of 5.00 m) as a cost-effective alternative to our standard square mesh sizes!

The mesh is transferred in one piece which means the net is produced without the end seams.

Ask us for a tailor-made quote for individual complete systems including planning, delivery and assembly – nationwide!

From 2.00 m net height
mesh size 50 x 200 mm.
This cost-effective mesh size is
entirely appropriate for ball play.

From 2.00 m net height
mesh size 50 x 100 mm.
This mesh size is
hard to climb over.

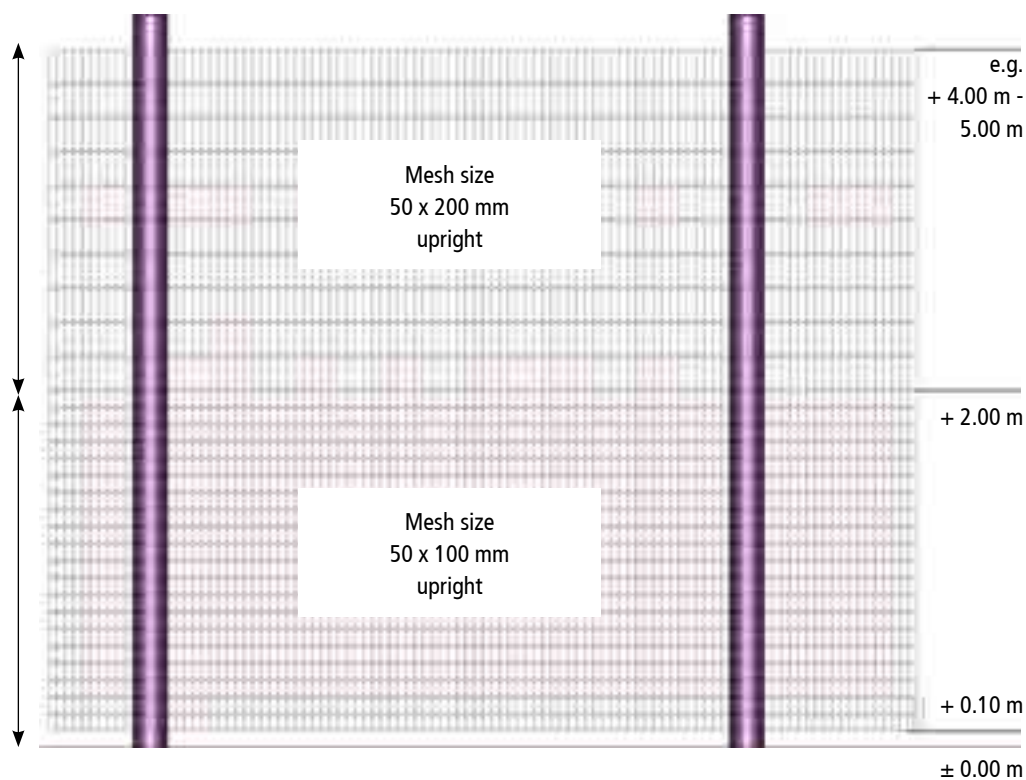



Knotless net with steel wire strand insert "Mahulan Steel"

This knotless net looks just like HUCK's standard textile nets but has a stainless steel wire strand insert to protect it from vandalism while still offering high levels of sound-proofing.

Mesh size: approx. 105 mm square mesh composition

Art. no. 9830-105 net width 3 m
Art. no. 9840-105 net width 4 m

Composition Art. 9830-105

Polyester "Mahulan Steel" safety net, knotless, with stainless steel wire strand insert (Ø 0.5/4.5 mm)

Mesh size 105 mm, fixed net width 3.00 m, colour: 01 green

Composition Art. 9840-105

Polyester "Mahulan Steel" safety net, knotless, with stainless steel wire strand insert (Ø 0.5/4.5 mm)

Mesh size 105 mm, fixed net width 4.00 m, colour: 01 green

Mesh size: approx. 60 mm square mesh composition

Art. no. 9830-060 net width 3 m
Art. no. 9840-060 net width 4 m

Composition Art. 9830-060

Polyester "Mahulan Steel" safety net, knotless, with stainless steel wire strand insert (Ø 0.5/4.5 mm)

Mesh size 60 mm, fixed net width 3.00 m, colour: 01 green

Composition Art. 9840-060

Polyester "Mahulan Steel" safety net, knotless, with stainless steel wire strand insert (Ø 0.5/4.5 mm)

Mesh size 60 mm, fixed net width 4.00 m, colour: 01 green

SMALLER SIZE SUPPLEMENTS:

Nets under 5 m² + 100 %,
Nets under 10 m² + 35 %,
Nets under 20 m² + 20 %, for each net!

Separate fastening devices upon request
or upon detailed consultation!



Polyester "Mahulan Steel" net, knotless, with steel wire strand insert

Looks like a completely normal goal net but has a special hidden talent. Its stainless steel wire strand core protects this HUCK net from

vandalism and is suited, for example, to unsupervised public sports areas. Without doubt a worthwhile investment!



"Mahulan Steel" slam space goal net

Art. no. 9964

The goal net is supplied with additional steel ropes and binders for secure and stable assembly.

Equipment

Polyester slam space goal net (Ø 4.5 mm), knotless, with "Mahulan Steel" stainless steel wire strand core (Ø 0.5 mm)

Mesh size approx. 10 cm, square mesh composition, colour: 01 green

Excluding goal frame!

Technical data

Length:	3.00 m
Depth:	top 0.90 m, bottom 1.10 m
Height:	2.00 m



Tested in accordance with DIN EN 749

ASSEMBLY INFORMATION!

The goal nets should basically only be suspended within the goals. The net should not under any circumstances be pulled over the frame!



"Dralo®" slam space goal net

Art. no. 4064

Equipment

Steel wire rope (Ø 3 mm), galvanised

Mesh size approx. 10 cm, square mesh composition

includes anti-theft tension rope assembly kit

Excluding goal frame!

Technical data

Length: 3.00 m

Depth: top 0.90 m, bottom 0.90 m

Height: 2.00 m



Tested in accordance with
DIN EN 749



Dralo® – the wire rope net
(see Page 201)

ASSEMBLY INFORMATION!

The goal nets should basically only be suspended within the goals. The net should not under any circumstances be pulled over the frame!

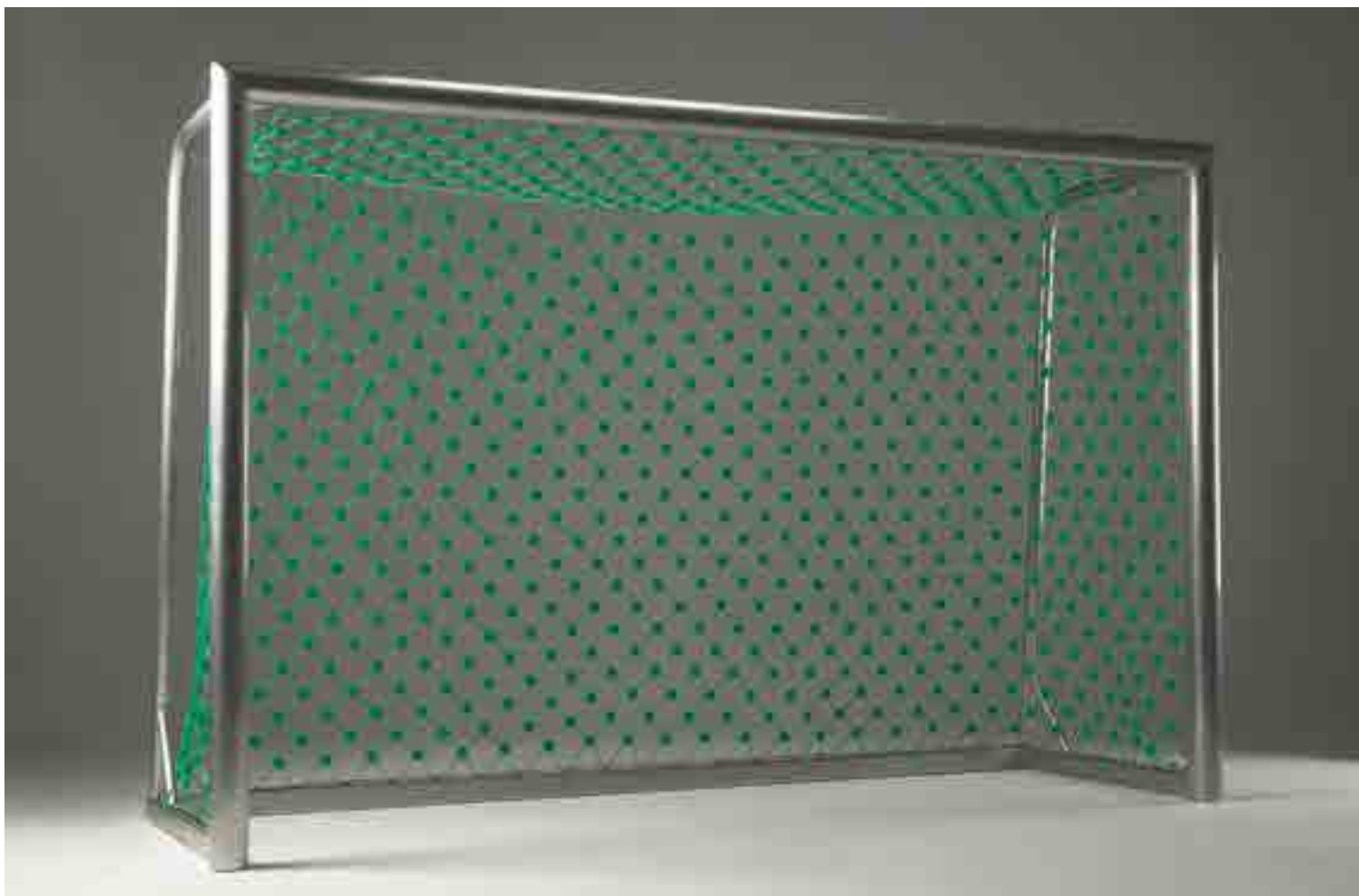

“Hercules” rope slam space goal net

Art. no. 4664

Equipment

Clip net (Ø approx. 2.5/5 mm), suitable for handball goals DIN EN 749, with net frame

Mesh size 11 cm, diagonal mesh layout, colour: 01 green

Excluding goal frame!

Technical data

Length: 3.00 m

Depth: top 0.90 m, bottom 1.10 m

Height: 2.00 m



Tested in accordance with DIN EN 749



SIGNIFICANTLY IMPROVED
with additional scratch-protection around the edge made from high-quality polyamid mounts!

NOTE ON ASSEMBLY!

Always hang the goal net inside the goal frame.
Never pull the net over the frame!

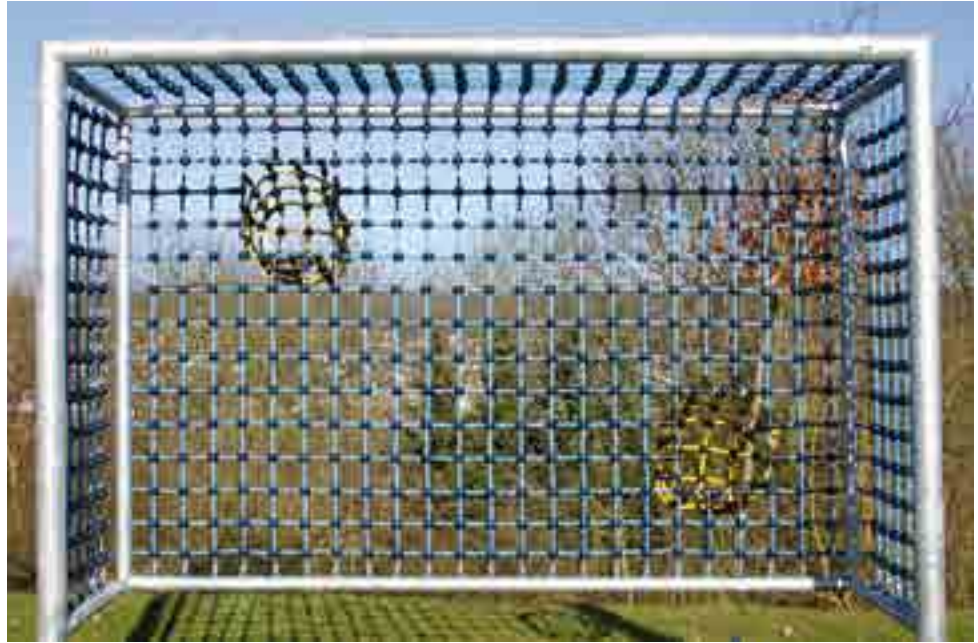
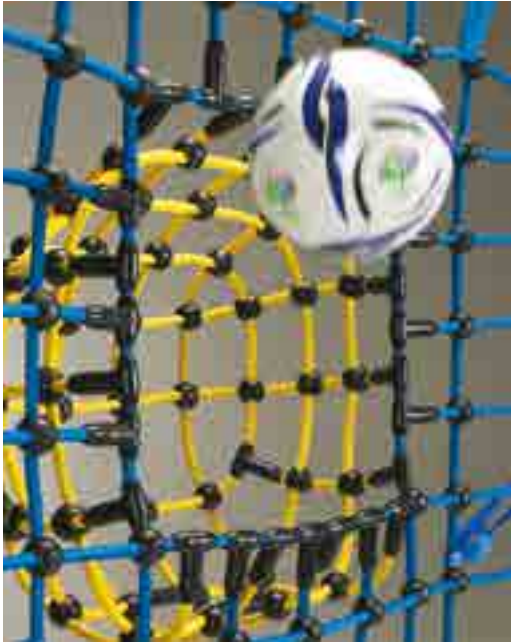

"Goalie" slam space goal

Art. no. 4666-130 Mesh size 13 x 13 cm

Equipment

Made from Hercules rope (Ø 16 mm, 6-strand, with steel core), colour: 04 blue

2 inner-goal baskets (60 x 60 cm) made from Hercules rope (Ø 16 mm, 6-strand, with steel core), colour: 05 yellow

Steel goal frame (Ø 102/76 mm), hot-dip galvanised, for concreting in

Technical data

Length: 3.20 m

Depth: 1.00 m

Height: 2.15 m



Tested in accordance with
DIN EN 749

HUCK's slam space goals – made for football and handball – withstand the highest demands. For this reason, HUCK's steel posts come with a 15-year guarantee against rust erosion and the net is guaranteed for 5 years.

You can order the net without the two inner-goal baskets.

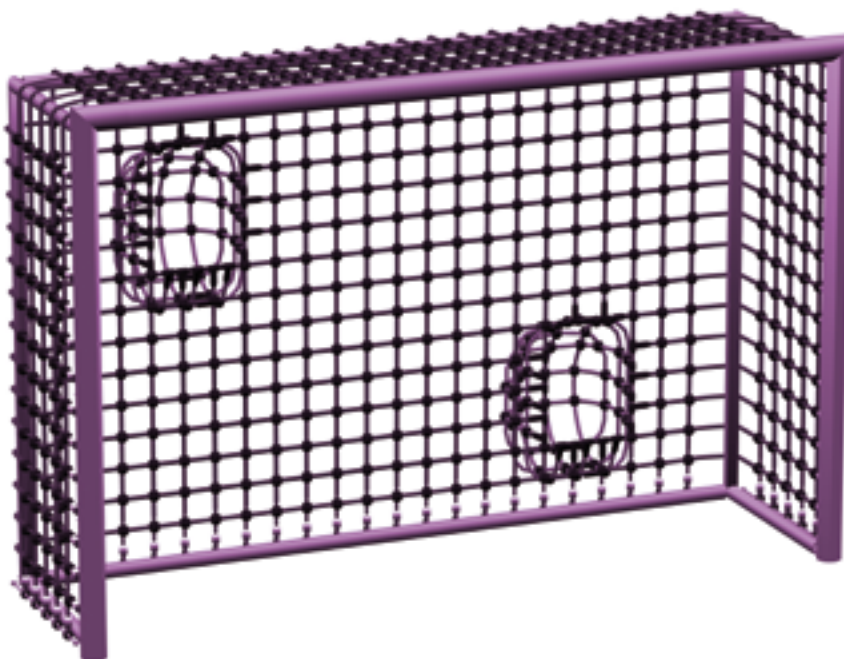

Upon request also available as a special design in other net sizes 2.00 x 1.50m (Length x height), depth 0.90m.



“Goalie-Sport” Football area goal

Art. no. 4665

Equipment

Hercules rope net (ø 16mm, 6-strand, with steel core), colour: grey

HUCK knot balls, colour: black

Steel goal frame (ø102/76mm, Hot-dip galvanized, also available painted for a surcharge

2 screw-in ground anchors for stability

Technical data

Length: 3.20 m

Depth: 1.00 m

Height: 2.15 m



Tested according to EN 749 Freely accessible multi-sports equipment

NEW



Strong – stable – durable



Complete volleyball net setup

Art. no. 4674

Equipment

With round pegs and side tension ropes, volleyball net made from polypropylene with steel core (clip net), (Ø approx. 2.5/5 mm), 1.00 x 9.50 m
Mesh size 100 mm (delivered from factory), colour: 01 green

Volleyball net with steel posts

Art. no. 4674-2

Equipment

Net with steel posts (Ø 16 cm), hot-dip galvanised, to concrete in
Net size 1.00 x 9.50 m, side tension ropes not obligatory

1000x tested! 



The unbreakable, stylish volleyball net – fits any standard volleyball post.

Volleyball net with steel core (clip net) not including posts

Art. no. 4674-1

Equipment

(Ø approx. 2.5/5 mm) Mesh size 100 mm
Net size 1.00 x 9.50 m (international guidelines), colour green

Dralo® volleyball net

Art. no. 4674-10

Equipment

Steel wire rope (Dralo®) (Ø 2.00 mm), galvanised, mesh size 100 mm
Net size 1.00 x 9.50 m (international guidelines)
Edging made from 160 mm-wide, coated fabric with HUCK imprint for use with standard volleyball posts



THEFT-PROOF!

↑ For end fastening the clamps are pushed completely to the top and closed, thus securely attaching the net and protecting it from theft!

← Clamps pre-assembled.

Basketball net single

Art. no. 4677-2

Equipment

Hercules (Ø 5 mm, 6-strand, with steel core), colour: 01 green

Fits any standard basket, theft-protected assembly with integrated clamps

Noise-reducing chains

1000x tested!





Sun sail to protect against sun and rain

To provide shade for horses or at the playground, HUCK offers the perfect sun protection from early Spring into late Autumn.

With our fabric sun protection systems you can cover the largest of areas – at a reasonable price. Ask us for advice!

The advantage of HUCK's fabric sun protection systems is that we can make them just how you want them. These covers are designed to fit the area you want to cover which means they're built to last.

More colours available, depending on the quality of fabric you order. Built-in window for year-round use. Give us a call and choose from a variety of fabrics– for protection from the sun only, or from the wind and rain, too.

Standard colours:

Shade: 50:50

light green (010), dark green (015), blue (04), red (07), orange (03), silver (66), terracotta (76), cream (86)

Shade: 90:10

dark green (015), blue (04), silver (66), cream (86)



"Rheinbad" installed in Düsseldorf, made by HS-Linie





Combined sun sail system, by Schaffert



Gladenbach swimming pool



Sun sail designed to be used all year round



2-part triangular sail



Lebenshilfe Braunfels (association for people with mental disability)



2-Part sun sail, Co. Götze



Sun protection covering an outside area at a kindergarten approx. 15.00 x 11.00 m (by Groh)



Sun pavilion cover combination

Art. no. 5782-1-04 without ground sleeves

Art. no. 5782-2-04 with ground sleeves

Permanent mounting
and height adjustable!

Equipment

Awning made from water-permeable and breathable fabric (blue, other colour available on request)

Includes hot-dip galvanised steel pipes (Ø 76 mm), special paint included in delivery

Can be ordered with or without ground sleeves

Technical data

Dimensions: 5.50 m x 5.50 m

Space requirements
on ground: 6.90 m x 6.90 m



SIMPLY CLEVER!

Suitable for posts Ø 76 mm in diameter, the slip-on sleeves can be adjusted to any height and automatically fixed through the anchoring.

Sun sail

Art. no. 5760-04 6.00 x 6.00 m

Art. no. 5740-04 4.50 x 4.50 m

Equipment

Breathable polyethylene fabric, colour: 04 blue

with guy ropes and 2 robust aluminium support poles (Ø 40 mm, length 3.00 m)

Stainless steel slip-on sleeve

Art. no. 5785 one for each support post

Equipment

Handle opening and 8 mm (Ø76 mm) steel-strength eyelets



Sandpit awning

Art. no. 720-015

Equipment

Water-permeable and breathable plastic fabric, UV-proof (015 dark green, 010 light green, 07 red, 04 blue, new awning colours: orange, silver, terracotta, cream)

with reinforced edges and shade eyelets (0.5 m distance between each)

ORDERS WITHOUT OVERHANG:

Please specify sand pit measurements

ORDERS WITH OVERHANG:

Please specify the final measurements of the awning/net.

The usual overhang is 20 cm on each side.



NO CONTAMINATION THROUGH:

- ⊖ Animal excrement
- ⊖ Foliage
- ⊖ Falling leaves

Rubber edging cord

Art. no. 2126

Equipment

Ø 6 mm (red/white), to secure the awning

we recommend attaching polyethylene buttons (art. no. 720)

Polyethylene buttons

Art. no. 720

Equipment

With stainless steel screws, to hang up the rubber edging cord

we recommend a distance of 60 cm between each

Climbing Nets, Ropes & Ladders

= a unique experience

Climbing has a positive influence on children's motor development. The setting needed for this special experience is provided by rope play equipment with climbing nets, which also meet the required safety standards. With the climbing nets acting as safety nets, children can climb to greater heights. These ropes are especially appealing because they swing, bounce and vibrate, increasing the challenge of the climb. Rope ladders and ropes round off the colourful world of play: It's great fun to clamber up to a play platform on a rope ladder or even on a free-swinging rope – an experience where young adventurers are bound to get what they came for. That's why HUCK has a large selection of climbing nets, rope ladders and ropes available in a variety of colours, lengths and materials.



Climbing nets



Climbing is one of the basic experiences in a child's development. Our climbing nets now mean there are even more fun and exciting ways to combine a whole range of playground components.

The net as a climbing component: size, colour and shape are entirely made to order. A hard-wearing material for seemingly difficult constructions. Sophisticated technology allows them to be secured to any secondary equipment. We deliver climbing nets to suit your needs. All nets are fitted with the tried and tested knot system. Tell us the colour, mesh size and overall size you want, and we'll deliver tailor-made climbing nets and advice on fixing options.

Our quality is in the detail

We believe that a play equipment item can only be as good overall as its individual components. So, to us, the selection of materials is key. High quality ropes and rope ties are what we believe guarantee the long life of a product.

Make the most of the wide-ranging advantages to be had by using our climbing nets.

We plan, produce and deliver individual climbing nets made to your specifications. All nets are fitted with the tried and tested knot system. Tell us the colour, mesh size and overall size of the nets you want – we recommend your attachment options.

⊕ Prior to planning, our colleagues advise and offer support on technical feasibility.

⊕ We use high quality rope and fixing materials (see the specifications on pages 236-240).

⊕ 6-strand Hercules rope with steel core for outdoor areas and places at risk from vandalism and 4-shaft polypropylene rope without steel core as soft-play material for indoor toddler areas.

⊕ Overall conformity with safety criteria set out in the European norm on play equipment EN 1176.

⊕ We can produce any net shape you like (3-sided or more, trapeze, spider net shape, circular) or set them up as a net tunnel, chimney or bridge.

⊕ We can produce for any size up to extra large play areas.

⊕ Onsite replacement or repair options for individual rope sections and ties. Avoid the unnecessary, costly replacement of large-scale net components or complete play equipment.





Climbing nets made from Hercules rope

Equipment

Hercules rope (Ø 16 mm), 6-strand, with steel core

Knot-tied

Colours: 01 green, 04 blue, 05 yellow, 06 black, 066 light grey, 07 red, 08 hemp, 09 multicoloured

Art. no.	Description	Mesh size in cm
4316-130	Hercules, Ø 16 mm	13
4316-250	Hercules, Ø 16 mm	25
4316-300	Hercules, Ø 16 mm	30
4316-350	Hercules, Ø 16 mm	35
4316-400	Hercules, Ø 16 mm	40
4316-500	Hercules, Ø 16 mm	50

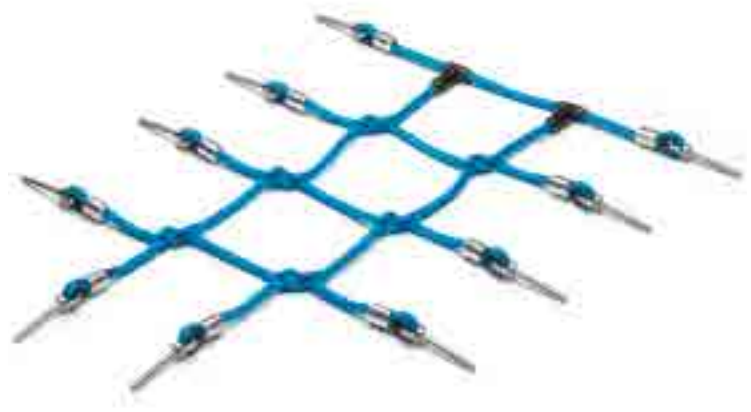

Polypropylene climbing nets

Equipment

Multi-strand polypropylene rope (Ø 16 – 25 mm), UV resistant without steel core

Knot-tied connection

Colours: 03 orange, 04 blue, 08 hemp-coloured

Art. no.	Description	Mesh size in cm
4116-110	PP, Ø 16 mm	11
4116-250	PP, Ø 16 mm	25
4116-300	PP, Ø 16 mm	30
4116-400	PP, Ø 16 mm	40
4116-500	PP, Ø 16 mm	50
4120-250	PP, Ø 20 mm	25
4120-300	PP, Ø 20 mm	30
4120-400	PP, Ø 20 mm	40
4120-500	PP, Ø 20 mm	50
4125-250	PP, Ø 25 mm	25
4125-300	PP, Ø 25 mm	30



Important! When you order please specify:

- 1) Lightweight frame
- 2) Intended attachment side
- 3) Fixing solution
- 4) Length of required attachment (length of threads)
- 5) Rope colour (refer to the colour code above)

Smaller size supplements for climbing nets

- under 1 m² + 50 %,
under 2 m² + 25 %



The Hercules quality



Abrasion-proof Hercules rope

The HUCK expertise comes into its own when it comes to ropes: Hercules rope consists of six twisted, 2.5 mm thick, steel strands, which are each composed of 7 individual, galvanised threads. The result is a rope that is extremely resistant and exceptionally robust.

Polyester yarn covering

Every strand is coated in a 6 mm-thick high quality polyester yarn. Unlike other synthetic materials, polyester is exceptionally abrasion-proof and has a very high colour and UV durability.

Secure attachment

Specially-made fittings create a secure attachment between the steel core and the fabric polyester jacket.

Special anti-abrasion proofing

Rope play equipment can easily get worn down. The HUCK Hercules rope has added protection from wear with a specially-made, clear outer proofing.

Abrasion testing

Regular abrasion tests on a specially-developed testing machine show no reduction in quality and attest its superiority over other types of rope. In the abrasion tests, a frictional object is rubbed back and forth over the rope's sur-

face ("double stroke"), until it reaches the steel core. The number of double strokes completed reflects the increased protection of our ropes in the face of repeated use.

Ties

Our ties (e.g. the tried and tested HUCK knot system) are made from high quality synthetic materials. They are extremely durable and particularly comfortable to play on, which sets them apart from the rest. They are formed without any sharp edges or corners.

Easy onsite replacement

The forward-thinking design of our components means replacing individual parts onsite is just as easy as replacing individual rope sections.

Colour-coordinated

For bright-coloured nets, we would normally use bright-coloured ties. In the case of natural rope colours (hemp), we install coordinating beige ties.

Connections



HUCK knot balls

Used worldwide for decades now, our HUCK plastic knot balls made from HDPE and 48mm in diameter, to connect a multitude of nets. Whether simple climbing nets or large net landscapes in different shapes and sizes – the HUCK knot ball provides a reliable and strong connection.

- ✔ Colour options in beige and black
- ✔ Balls in light beige colour tone for hemp coloured rope
- ✔ Round form without corners and edges for a pleasant feel
- ✔ Can be easily replaced



HUCK flax knot-tied

In the cross-stitch design for Hercules ropes or flax knot-tied designs for PP ropes, at the customer's request we use this new knot connection in order to highlight the rope. The HUCK flax knot-tied design is extremely popular for horizontal nets such as hammocks.

- ✔ Colour options depending on rope colour: blue, green, black, red, hemp and many more
- ✔ Comfortable for laying on and relaxing
- ✔ Brings rope to the fore!



HUCK stainless steel clip

For a few years now HUCK has also used stainless steel clips as Hercules rope connections. These are characterised by their high-quality material and clear design. At the customer's request our standard nets can also be designed with stainless steel clips.

- ✔ High-quality design, suits a multitude of rope colours
- ✔ Round form without corners and edges for a pleasant feel
- ✔ Extremely durable material

Attachment options for climbing nets, ropes, bridges, etc.

Rope loop

Art. no. 464 your choice of internal diameter



464

Plastic thimble black or beige

Art. no. 457 internal diameter 11 mm, for Hercules rope Ø 16 mm and Ø 18 mm



457

Plastic thimble white

Art. no. 457W internal diameter approx. 30 mm, for Hercules rope Ø 16 mm, Ø 18 mm and Ø 24 mm



457W

Stainless steel thimble

Art. no. 457VA internal diameter 30 mm, for Hercules rope Ø 16 mm and Ø 18 mm



457VA

Plastic round thimble black

Art. no. 457R internal diameter approx. 35 mm, for Hercules rope Ø 16 mm and Ø 18 mm



457R

Plastic full thimble black

Art. no. 457V opening diameter 11.50 mm, for Hercules rope Ø 16 mm and Ø 18 mm



457V

Galvanised thread bolts grouted

Art. no. 454V thread thicknesses M8, M10 or M12, your choice of bolt length



454V



454



463



455B



455



447



449



440-8G

Galvanised thread bolts including plastic adapters, black or beige

Art. no. 454 thread thicknesses M8, M10 or M12, your choice of bolt length

Plastic bolt adapter without thread bolts, black or beige

Art. no. 463 internal thread M8, M10 or M12

Galvanised nuts including thread bolts

Art. no. 455 B thread thicknesses M8, M10 or M12, your choice of bolt length

Galvanised nuts without thread bolts

Art. no. 455 internal thread M8, M10 or M12

Plastic joint adapter including thread bolts, black or beige

Art. no. 447 thread thicknesses M8, M10 or M12, your choice of bolt length

Plastic joint adapter without thread bolts, black or beige

Art. no. 449 internal thread M8, M10 or M12

Stainless steel M8 safety clamp (curved shape)

Art. no. 440-8 G also available straightened

441-6

442

452

453

436

461 V

461

466

Stainless steel M6 safety clamp (straight) including plastic adapters, black or beige

Art. no. 441-6

Stainless steel frame with 2 M6 x 70 mm wooden screws including plastic adapters, black or beige

Art. no. 442

Stainless steel frame with 2 M6 x 70 mm wooden screws

Art. no. 452

Galvanised steel ring M10 x 50 mm

Art. no. 453 also available in sizes M8 x 40 mm and M10 x 60 mm

Plastic rope end connector black or beige

Art. no. 436 for Hercules rope Ø 16 mm, Ø 18 mm or Ø 24 mm

Chain no. 6 galvanised (short), grouted

Art. no. 461 V

Chain no. 6 galvanised (short) including plastic adapters, black or beige

Art. no. 461 standard chain length 3 links (see photo), other chain lengths available at extra charge

Plastic rope ties black or beige

Art. no. 466 for Hercules rope Ø 16 mm



Stainless steel chain adapter no. 6

Art. n. o. 461-6 for connecting chain no. 6 to M16 thread connector



Stainless steel chain adapter no. 8

Art. n. o. 461-8 for connecting chain no. 8 to M16 thread connector



Stainless steel M8 chain shackle

Art. n. o. 440-30 movable connector for attaching chain no. 6 or 8 to Hercules rope Ø 16 mm



Stainless steel bearing adapter M16

Art. n. o. 430 bearing connector for attaching shackle no. 8 or 10 and/or 2- or 3-eyelet shackle to M16 thread connector



Stainless steel bearing adapter M12

Art. n. o. 443 bearing connector for attaching shackle no. 8 or 10 and/or 2- or 3-eyelet shackle to M12 thread connector (internal thread)





Stainless steel thimble chain swivel

Art. no. 4603-20 swivel connector with special bearing sleeve for maximum swivel load of chain no. 6 or 8 to Hercules rope \varnothing 16 mm



Stainless steel 3-eyelet shackle including M10 cross bolts

Art. no. 440-20 ideal for corners on horizontal nets, for attaching Hercules rope \varnothing 16 mm or \varnothing 18 mm to chain no. 6 (incl. finger protection) and/or 8 or stainless steel bearing adapter



Stainless steel thimble swivel

Art. no. 4603-10 swivel connector for attaching stainless steel bearing adapter or bearing art. no. 4602 to Hercules rope \varnothing 16 mm



Stainless steel nut M16

Art. no. 455-16 with small eyelet (normed internal diameter), for Hercules rope \varnothing 16 mm or \varnothing 18 mm



Stainless steel 2-eyeletshackle

including M10 cross bolts

Art. n. o. 440-10 without fittings, ideal for corners on horizontal nets, for Hercules rope Ø 16 mm or Ø 18 mm



Stainless steel turning peg

for chain no. 8

Art. n. o. 4603-20 (without chains), for Hercules rope Ø 16 mm or Ø 18 mm



Plastic T-connector

black or beige

Art. n. o. 445 for Hercules rope Ø 16 mm



Plastic T-joint

black or beige

Art. n. o. 448 for Hercules rope Ø 16 mm



Plastic knot system

black or beige
Art. n. o. 444-1 for Hercules rope Ø 16 mm

Plastic knot system (2-part), black or beige

Art. n. o. 444-10 for Hercules rope Ø 16 mm



Plastic rope stopper (2-part), black or beige

Art. n. o. 465 for Hercules rope Ø 16 mm, to fix individual components to the rope however you choose, as 2-part can also be installed afterwards

Our fastening devices made from galvanised steel are also available (if not already itemised) in stainless steel quality.

The 2-part plastic connector is especially suited to maintenance and repair work and can be subsequently put on pre-installed rope.

Accessories for robinia posts (from page 86)

Stainless steel plates incl. screws

Art. no. 4575-01-VA set for post connection with chain no. 6

Equipment

1 stainless steel split washer (Ø 60 mm)

1 stainless steel perforated disc (Ø 60 mm)

4 rounded head screws 5.50 x 19 mm

1 rounded head screw 5.50 x 42 mm

Stainless steel M8 chain shackle incl. chain

Art. no. 4575-02-VA set for post connection with stainless steel plates

Equipment

1 stainless steel chain no. 6, length 50 cm

1 stainless steel M8 chain shackle
(art. no. 440-30)

Assembly example

Further information on our robinia posts can be found from page 82 as well as on page 277.



Gymnastics rings per piece

Art. no. 4 7 4 1 4741 with Hercules hanging ropes, rope colours: 01 green, 04 blue, 05 yellow, 07 red, 08 hemp

Art. no. 4 7 4 0 with polypropylene multifilament hanging ropes, rope colours: 03 orange, 04 blue, 08 hemp

Art. no. 4 7 4 not including rope

Equipment

Made from polyester 28 x 240 mm

Colour of rings: white

Total length approx. 1.50 m (as standard) other lengths available on request – specify with your order!

Upper rope ends include adjustable chain no. 6, galvanised



Roman rings per piece

Art. no. 4 0 4 with Hercules hanging ropes, including eye bolts

Art. no. 4 0 4 - 1 with chain (Ø 6 mm), including eye bolts

Art. no. 4 0 3 not including rope

Equipment

Made from steel with plastic grip 10 x 140 mm

Upper rope end each fitted with M12 nut, galvanised, includes 200 mm bolts, rope or chain length 20 cm

Colour: red (other colours available on request)

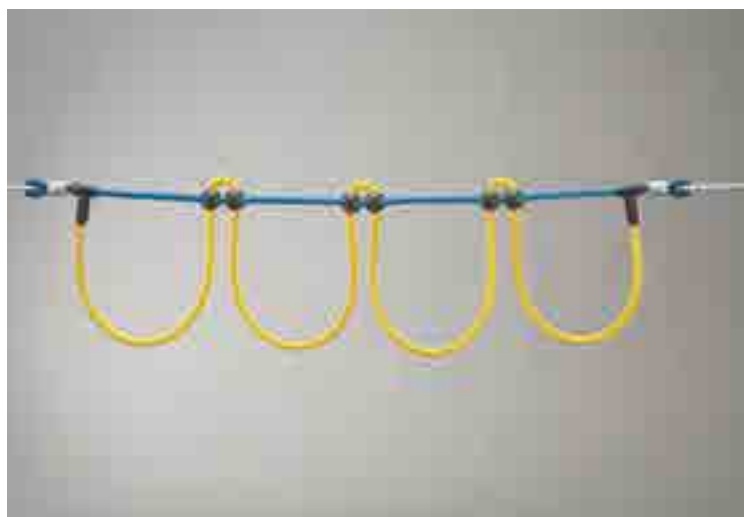

Garland clamber rope

Art. no. 4 8 9 - 10

Equipment

Hercules rope (Ø 16 mm, 6-strand, with steel core)

M12 nuts on both sides, galvanised, includes 200 mm bolts

Rope colours: 08 hemp, 07 red, 05 yellow, 04 blue, 01 green (standard colour combination is blue/yellow)

Standard length 3.00 m (other lengths available on request – specify with your order)



Clambering loop

Art. no. 4743

Equipment

Made from Hercules rope (Ø 16 mm)

Grip in black or beige

Length from suspension rope to grip: 220 mm

Rope colours: 01 green, 04 blue, 05 yellow, 06 black, 07 red, 08 hemp

Recommended hanging distance: 500 mm

The suspension rope (art. 4821 or art. 482) for attaching the holding loop is not included in the price and has to be ordered separately.

Individual holding loops (without suspension rope) cannot be used!



Q Slackmaster combination 2
(page 50)



Clambering rings

Art. no. 4742

Equipment

Made from polyester (Ø 240 mm)

incl. Hercules connection rope (Ø 16 mm, 6-strand, with steel core) and stainless steel swivel

Length from suspension rope to ring: 170 mm

Colours: 08 hemp, 07 red, 05 yellow, 04 blue, 01 green (standard colour combination is blue/yellow)

Recommended hanging distance: 500 mm

The suspension rope (art. 4821 or art. 482) for attaching the holding loop is not included in the price and has to be ordered separately.

Can also be delivered with eye bolt for connection to fixed constructions



Q Slackmaster combination 2
(page 50)

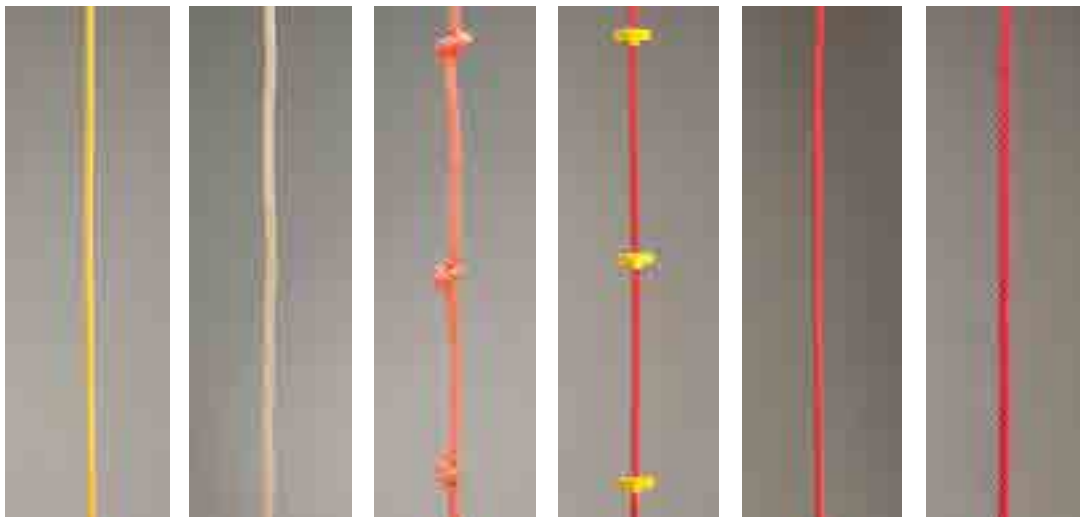

Ropes

Ropes attached at one end (up to 2.00 m in length) must be at least 60 cm away from the nearest fixed part of equipment. With ropes that are 2-4 m in length, this gap increases to 1 m (according to EN standard). Standard length: 2.00 m, other lengths available on request. **All ropes are fitted with a thimble and ring at the top and a polyethylene end cap at the bottom, as standard.**

Please see Page 245 for details of lengths available for order.

Stipulations set out in EN 1176-1 (paragraph 4.2.12) apply!

482 479
480
481 483
4821 484

Hercules climbing rope length 2.00 m

Art. no. 482 Ø 18 mm
Art. no. 484 Ø 25 mm, 08 hemp, 07 red, 05 yellow, 04 blue
Art. no. 479 Ø 16 mm

Equipment

Thimble with galvanised steel ring 10 x 50 mm at top, polyethylene end cap at bottom

Colours: 08 hemp, 07 red, 05 yellow, 04 blue, 01 green

Polypropylene climbing rope length 2.00 m

Art. no. 480 Ø 24 mm

Equipment

Thimble with galvanised steel ring 10 x 50 mm at top, polyethylene end cap at bottom

Colours: 08 hemp, 04 blue, 03 orange

Polypropylene climbing rope knotted, length 2.00 m

Art. no. 481 Ø 24 mm

Equipment

Knotted, thimble with galvanised steel ring (10 x 50 mm) at top, polyethylene end cap at bottom

Colours: 08 hemp, 04 blue, 03 orange

Hercules climbing rope with climbing supports, length 2.00 m

Art. no. 483 Ø 18 mm

Equipment

Thimble with galvanised steel ring 10 x 50 mm at top, polyethylene end cap at bottom

Colours: 08 hemp, 07 red, 05 yellow, 04 blue, 01 green

Climbing support colours: yellow or red

Hercules clambering rope length 3.00 m

Art. no. 4821 Ø 18 mm

Equipment

Thimble with galvanised steel ring 10 x 50 mm at both ends

Colours: 08 hemp, 07 red, 05 yellow, 04 blue, 01 green



Ground anchor chain + screw-in ground anchor



38250

Ground anchor chains for climbing rope

Art. no. 4825

Equipment

Chain no. 6 galvanised, length approx. 40 cm (in the ground) (supplement for rope to be attached at both ends)

Screw-in ground anchor not included (Art. no. 410)

Screw-in ground anchor

Art. no. 410

Equipment

Steel (Ø approx. 10 mm), hot-dip galvanised

Length approx. 40 cm

ATTENTION! For ground anchoring the length of the rope ordered corresponds to the height of suspension!

Climbing rope heavy-duty

Art. no. 38250 length 2.50 m

Art. no. 38300 length 3.00 m

Art. no. 38350 length 3.50 m

Art. no. 38400 length 4.00 m

Art. no. 38000 length per extra m

Equipment

Polypropylene (Ø 33 mm), without steel core, grass colours

Galvanised rope holder at top, plastic sleeve at bottom

Stated length: entire rope length incl. rope holder

Ladders

Rungs made from acacia wood, plastic or aluminium (rope distance approx. 35 cm). All ladders made to order – any length and a number of fittings available.

Standard equipment: thimble and ring at top. Recommended height off ground: 40 cm to the first rung. Order length always from hanging point to lowest rung. Max. load per ladder approx. 150 kg.



Rope ladder with aluminium rungs

Art. no. 42

Equipment

Made from Hercules rope (Ø 16 mm, 6-strand, with steel core)

3 aluminium rungs per metre with fixed side caps

Colours: 01 green, 04 blue, 05 yellow, 07 red, 08 hemp



Rope ladder with acacia wood rungs

Art. no. 44

Equipment

Made from Hercules rope (Ø 16 mm, 6-strand, with steel core)

3 acacia wood rungs per metre

Colours: 01 green, 04 blue, 05 yellow, 07 red, 08 hemp



Rope ladder with plastic rungs

Art. no. 44-10

Equipment

Made from Hercules rope (Ø 16 mm, 6-strand, with steel core)

3 plastic rungs (yellow, red or black) per metre

Colours: 01 green, 04 blue, 05 yellow, 07 red, 08 hemp



Polypropylene rope ladder with acacia wood rungs

Art. no. 40

Equipment

Made with polypropylene multifilament ropes (Ø 16 mm)

3 acacia wood rungs per metre

Colours: 08 hemp, 04 blue, 03 orange



Screw-in ground anchor

Art. no. 410

Equipment

Steel (Ø approx. 10 mm), hot-dip galvanised

Length approx. 40 cm

Ladder extension

Art. no. 4826

Equipment

Please specify length and material when you order (at both ends of the rope or going up into a V-shape) (light-weight installation height: from top of fall protection to the bottom of head beam)

Lengths available for order

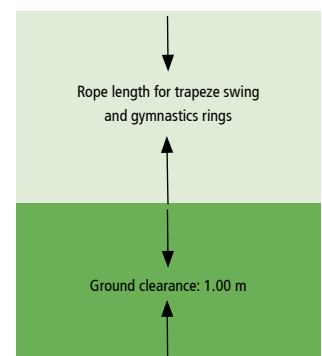
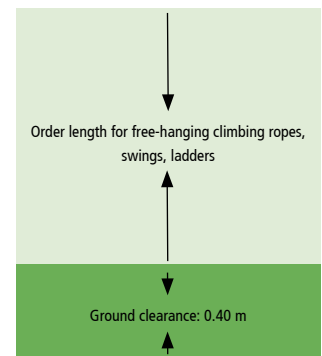
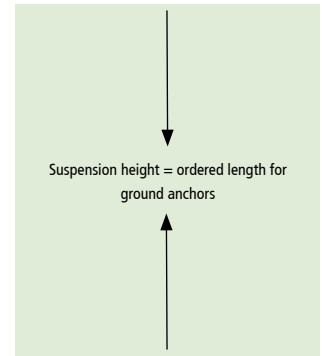

Accessories range – for customised playworlds

Individual adventure playgrounds and play equipment require individual accessories for each age group. HUCK has developed a number of detailed design solutions to complement your adventure world perfectly. These include our lawn protection mats, for example. Our solution is as simple as the problem of trampled grass under a swing is unavoidable! Or how about our play equipment stands? You can even turn a grey flat roof into a bright playworld! Assembly is easy thanks to the practical HUCK anchors. There are more practical accessories on the following pages.



Lawn-protection mat for swings

Art. no. 4655

Description

Hard-wearing, elasticated, recyclable rubber linked mat

Thickness approx. 20 mm, size 0.90 x 1.50 m

Colour: 06 black

For simple, secure anchoring

Trampled grass increases the risk of accidents at playgrounds. There is a danger of slipping over in wet weather, and when it's dry the bare ground is as hard as concrete. Damaged grass roots find it hard to grow back. We recommend lawn-protection mats so that the grass stays as it should. The mats graft themselves almost entirely into the grass. Easily installed even after the grass has been damaged.



Lawn-protection grid mat

Art. no. 4656

Description

Plastic-coated, tight-mesh linked mat, abrasion-proof, UV-proof, mow easily over it

Thickness approx. 2 mm, fixed width 5.00 m (off the roll), length made to order

Colour: 06 black

Simple installation – just dig in around edge

Rain and frequent use of popular playground items quickly wear out grass areas. This gives the ground a poor appearance and can cause accidents. Lawn-protection mats are an effective measure against this, ensuring that kids can run around safely in any weather.

Slope reinforcement with roll-link mats

For individual safety on the side of hanging play equipment or slides we offer an inexpensive, simple and long-lasting solution

These are produced from the rubber elements which have been tried and tested for almost thirty years in the Hally Gally trampoline range and can be adapted to the terrain, is flexible, softens the fall and can be fixed into the ground soil with ground anchors without any problems at all.

After laying, the mats can be completely sown without disruptions to play. Thanks to the ingrowth of the mat the grass structure remains on a sustained and full basis.

Have a quote drawn up for your special building project!



Bollard

For a natural border for water features, paths, grass areas, etc. Quick and cost-effective assembly. With its steel core, the polypropylene rope can only be damaged if subjected to extreme levels of violence. The "hemp" colour fits harmoniously into urban designs. The recommended gap between posts is 2.50 m to 3.00 m. The rope is pulled through the posts to the desired length after delivery. To ensure that the rope doesn't slip, it is then fixed into an internal sleeve on each post.

Polypropylene rope with steel core per running metre

Art. no. 4990

Description

Ø 65 mm

With steel core (Ø 10 mm)

Rope colour: hemp

Centre bollard with 1 drill-hole

Art. no. 4990-4-10

Description

Larch posts, planed and varnished, split-heart centre, pressure-proofed, includes 1 drill hole for the rope (when ordering, please remember that the end bollard has two drill holes)

Ø 16 cm, length approx. 1.50 m

Fixing sleeves not included

End bollard with 2 drill-holes

Art. no. 4990-5-10

Description

Larch posts planed, varnished, split-heart centre, pressure-proofed

incl. 2 drill-holes for rope

Ø 16 cm, length 1.50 m, without fixing sleeves

Attachment sleeves

Art. no. 4990-10

Description

For internal attachment

Caution: You need 2 drill holes for the end bollard!





Post cap for Ø 100, 120, 140 or 160 mm, made from UV-resistant and colour-durable high density polyethylene, red

Art. no. 416-10/12/14/16

Post cap for Ø 180 or 200 mm, made from UV-resistant and colour-durable high density polyethylene, red

Art. no. 416-18/20



Black post caps for Ø 102, 160 or 180 mm, made from UV and colour-resistant HDPE, black

Art. no. 416-10-06/416-16-06/416-18-06

Steel post cap for Ø 102 cm, made from hot-dip galvanised steel

Art. no. 416-105

Buried ground anchor

We have good news, and not just for playground planners: HUCK has thought up a new solution that does away with labour-intensive concrete foundations for play equipment : buried ground anchors. They make it quick and cost-effective to assemble. The anchor plates are simply fitted into holes in the ground that are filled in.

The mini M-swing, for instance, can be ordered with this option. The play equipment is ready for use as soon as it is assembled as there is no more need to wait for the concrete to set.

If you want to move the play equipment, the anchors and posts can be easily removed and installed in a different location.



Ideal for assembly with guidance through parent initiative!

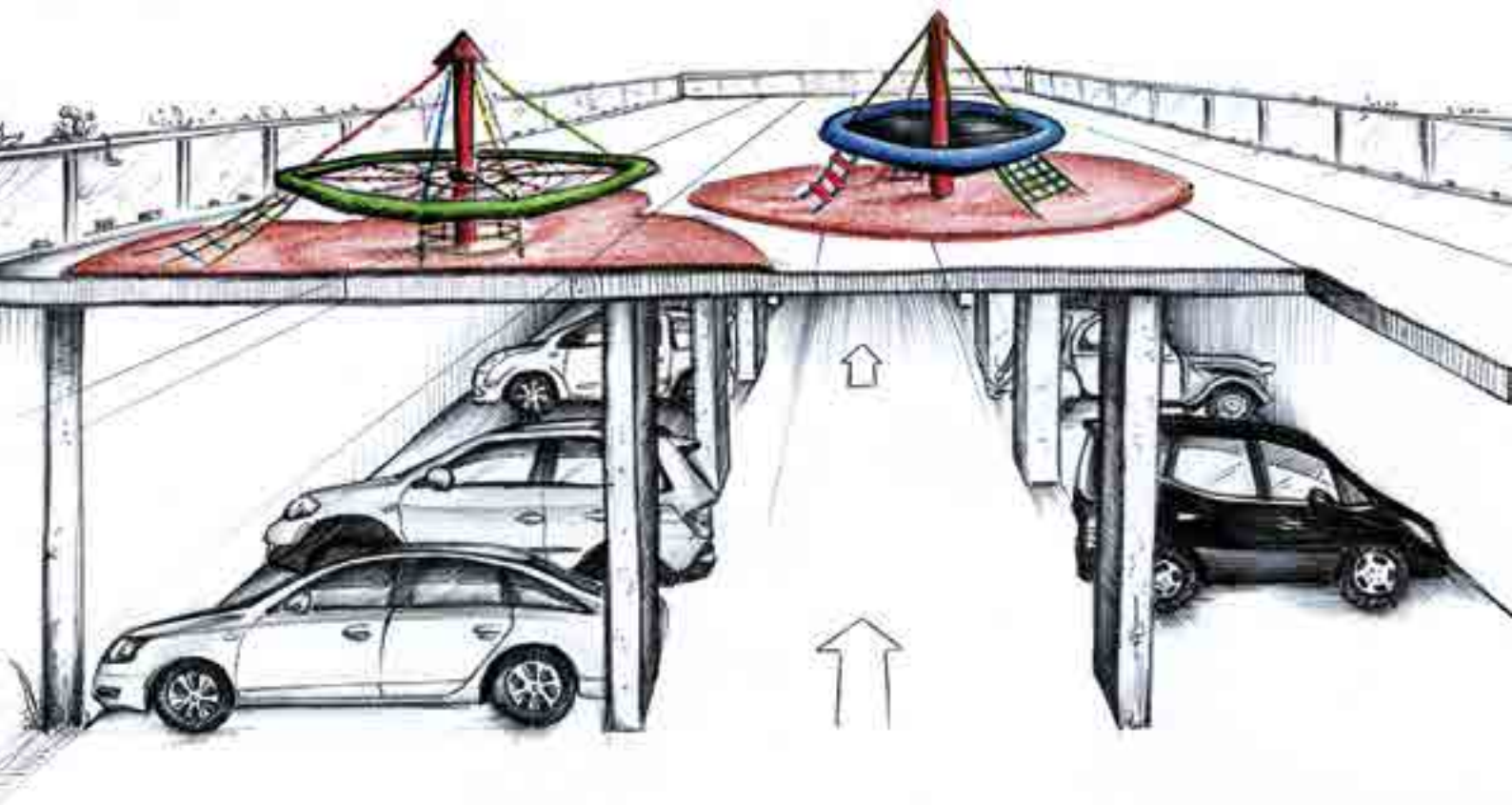

Design can be customised according to layout.

The HUCK installation solution for flat roofs

Creating interesting play areas on green flat roof tops – this can be done with the approved HUCK support set of 5 star-shaped tube struts. We can cater for any kind of roof top construction with individual solutions.

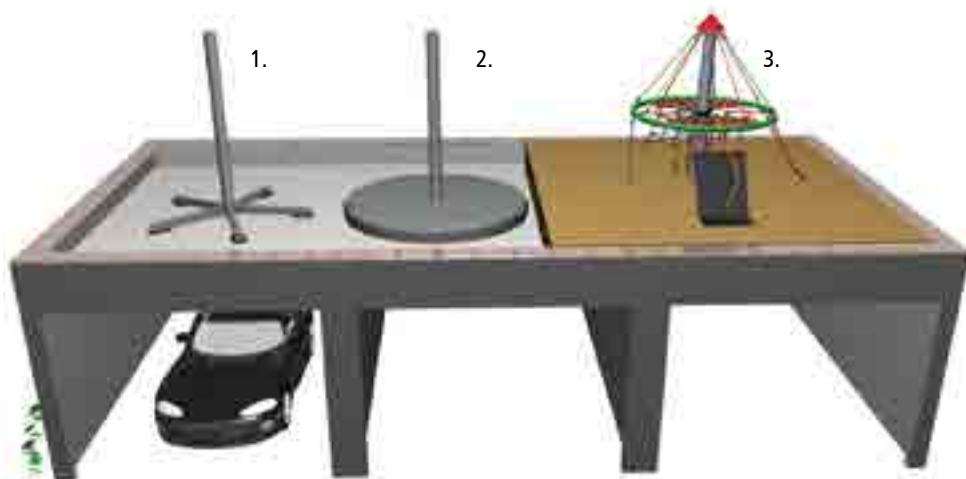

Design example:

1. Place supports with rubber bases (included in delivery) straight onto the roof surface (do not drill down)
2. Embed the support foot into approx. 10 cm of concrete depending on the location
3. Fill up to the desired level – ready!

Net Bridges & Net Tunnels

= Individuality made from HUCK system components

Are you looking for an individual solution for your project? We offer a made-to-order service! The following pages give examples of individual solutions which we have developed based entirely on the wishes of our customers. We combine standard components as well as customer-specific solutions. Using our expertise and many years of experience in rope play equipment, we are happy to help you get the perfect results for your indoor or outdoor projects. Whether you're thinking large or small – let us bring your ideas to life!



Net tunnel

Location: OBRA Kinderland / Austria

Realised by: OBRA Design, Ing. Philipp GmbH & Co.KG.

Net bridges

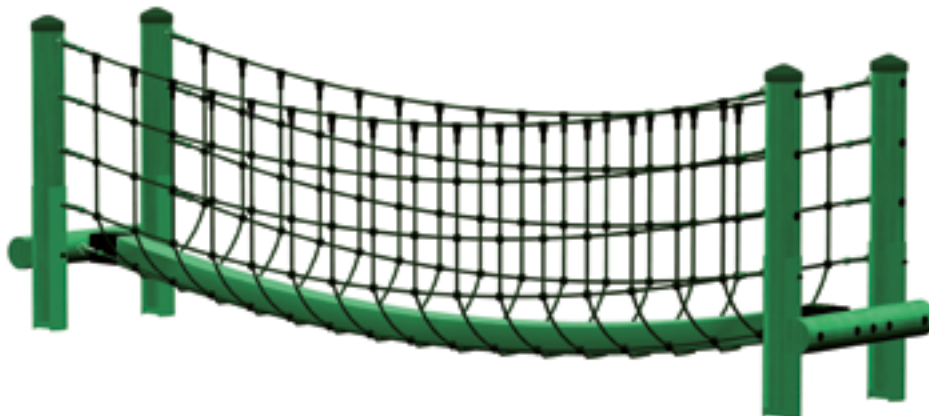

Jungle bridge including frame kit

Art. no. 4958

Technical data

Bridge length:	5.00 m, other lengths available on request!
Access components:	Douglas fir (Ø 180 mm), with specially-made post shoes (from a bridge length of 500 m with hot-dip galvanised steel frame)
Entrance height:	max. 0.40 m
Runner rope:	160-series polypropylene runner rope with steel core, 4-sided, plaited, abrasion-proofed
Handrail:	Hercules (Ø 16 mm, 6-strand, with steel core), Mesh size 30 x 30 cm, approx. 1.20 m high



Polypropylene running surface rope per running metre

Art. no. 4325-0090-08 Running surface: 90 mm

Art. no. 4325-0160-08 Running surface: 160 mm

Description

4-sided, plaited, high quality polypropylene rope (absolutely rot-proof), even running surface, steel rope inner (Ø 12 mm) as beam component

Weight per running metre approx. 5-11 kg



Jungle bridge per running metre

Art. no. 4954-300 Running surface approx. 90 mm

Art. no. 4956-300 Running surface approx. 160 mm

Handrail

Hercules rope (Ø 16 mm, 6-strand, with steel core)

Mesh 30 x 30 cm

Network ends: fixing components

Handrail height: Approx. 85 cm (1.20 m on request)

Running rope

4-sided, plaited polypropylene rope, with steel rope core, rot-proof

Runner rope ends: nuts

Running surface zusätzl. abriebimprägniert



Complete rope cable, total weight approx. 2 t, rope diameter 16 cm

End attachments for running surface rope

Art. no. 495

Description

Rope ends fitted with terminals and galvanised M16 nuts (option to include bolts), also for use on V-bridges (see page 254)

Length of bridges
up to max 5.00m.
Additional lengths
on request!



4930-005-050

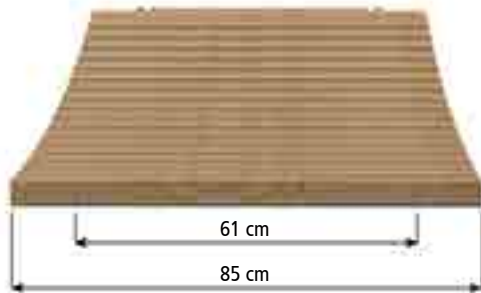

4930-005-075

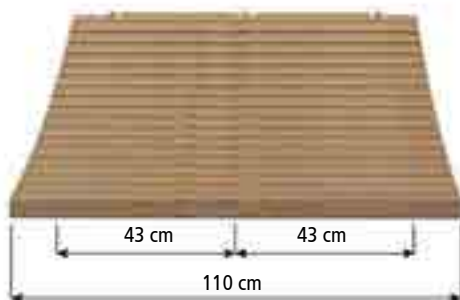

4930-005-100



4950

Net handrail for wooden or rubber steps, per running metre

Art. no. 4910-300 Mesh size 30 x 25 cm

Equipment

Handrail made from Hercules rope (Ø 16 mm, 6-strand, with steel core), handrail height approx. 85 cm including all attachment components for wooden frame (stainless steel or polyamide)

Combine a net handrail with our walkway for a customised bridge to meet individual requirements! Additional planks can be found page 260 onwards.



Wooden steps per running metre

Art. no. 4930-005-050 Applicable width 50 cm

Art. no. 4930-005-075 Applicable width 75 cm

Art. no. 4930-005-100 Applicable width 100 cm

Equipment

Larch rungs (Ø 45 mm), split-heart, approx. 95 mm wide, gaps of approx. 3 cm

Steel rope (Ø 10 mm) pulled taut and fixed in place

Frame assembly: With stainless steel nuts as standard (further attachment component options available)

Rubber floor steps per running metre

Art. no. 4950 Applicable width 55 cm, max. length 3.00 m

Equipment

Closed-in rubber steps, extremely tear-proof

Ends come with the option of specially-made metal fittings so they can be seamlessly connected to the tower or with extensions to attach them onto the frame itself before delivery

Rubber floor width approx. 0.65 m (applicable width 0.55 m)

Weight per metre approx. 6 kg

Max. length 3.00 m





Simple net bridge per running metre

Art. no. 4959-250

Equipment

- Ropes and nets made of Hercules rope (Ø 16 mm, 6-strand, with steel core)
- Mesh on running surface 30 x 30 cm
- Network ends as standard with nuts and bolts
- Handrail height approx. 85 cm
- including all attachment components for wooden frame (stainless steel or polyamide)

More customised walkways to be found on page 260 onwards.



Net bridge with additional wooden rungs, per running metre

Art. no. 4952

Handrail

- Ropes and nets made of Hercules rope (Ø 16 mm, 6-strand, with steel core)
- Mesh 40 x 60 cm
- Network ends as standard with nuts and bolts
- Handrail height approx. 85 cm

Running area

- Hercules rope (Ø 16 mm, 6-strand, with steel core), with wooden rungs
- Clear gap between wooden rungs 23 cm (in accordance with EN)
- Applicable width 80 cm
- including all attachment components for wooden frame (stainless steel or polyamide)

Please always check in advance the connections in the walkway area on both sides of the tower, frames (incl. any possible projecting platforms etc.) in order to avoid dangerous head dimensions according to EN 1176.



V-shaped net bridge per running metre

Art. no. 4957-300 Mesh 30 x 30 cm

Handrail

- Ropes and nets made of Hercules rope (Ø 16 mm, 6-strand, with steel core)
- Mesh 30 x 30 cm
- Network ends as standard with nuts and bolts
- Handrail height approx. 85 cm
- Running rope not included

Running area

- 4 adjacent Hercules ropes (Ø 16 mm, 6-strand, with steel core) with 5 cm gap between each
- including all attachment components for wooden frame (stainless steel or polyamide)



Net tunnel

Our net tunnels come in the most varied of styles. For custom-made items or as add-ons for existing play equipment. We only use Hercules rope with steel strands and polyester fabric covering. Its excellent abrasion-resistance and extremely long-lasting colour guarantee its good looks for years to come. Tunnels are round, 4-sided or 3-sided. You can even install these tunnels as vertical climbing chimneys. Give us a call and let us advise you!

Net tunnel with closed-in rubber steps up to max. 3.00 m in length, available on request.



Net tunnel made entirely from Hercules rope per running metre

- Art. no. 4970 Running surface: 0.75 m, height: 0.90 m
 Art. no. 4971 Running surface: 0.75 m, height: 1.20 m
 Art. no. 4972 Running surface: 0.90 m, height: 0.90 m
 Art. no. 4973 Running surface: 0.90 m, height: 1.20 m

Equipment

Ropes and nets made of Hercules rope
 (Ø 16 mm, 6-strand, with steel core)

Light-weight mesh size of running surfaces 11.50
 x 11.50 cm (in accordance with EN 1176), 3
 further sides mesh size approx. 30 x 30 cm

Network ends as standard with nuts and bolts

Additional tunnel designs as an attraction
 and alternative entry option in a multitude
 of variants is possible!



Numerous sizes, shapes and lengths can be realised in line with your ideas!

Climbing chimney per running metre

Art. no. 4610-1 Ø approx. 0.80 m

Equipment

- Ropes and nets made of Hercules rope (Ø 16 mm, 6-strand, with steel core)
- Mesh size approx. 30 x 30 cm
- Upper rope ends as standard with nuts and bolts
- Lower rope ends have a chain adapter + approx. 0.40 m chain no. 6, hot-dip galvanised

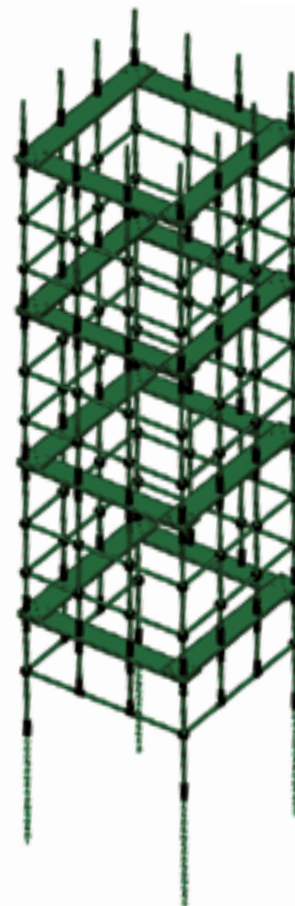

Tailor-made climbing chimneys



Frame – optimally designed

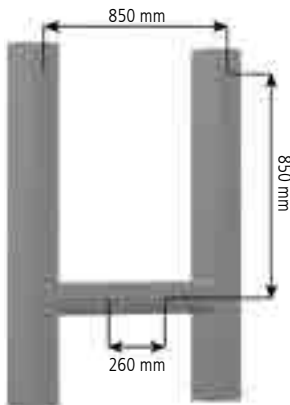

Handrail height: 85 cm, "Jungle" type
 Access width: 0.85 m (centre – centre)
 Height of sides: 0.85 m
 Mesh size: approx. 300 x 300 mm

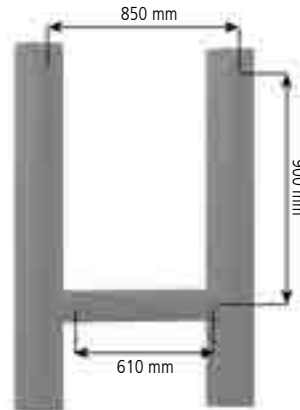

Handrail height: 85 cm, "Footbridge" type
 Access width: 0.85 m (centre – centre)
 Height of sides: 0.90 m
 Mesh size: approx. 300 x 250 mm

Beam length: Behind* posts, recommended connection type



Beam length: Between* posts

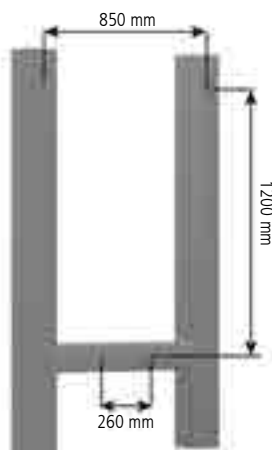

Handrail height: 120 cm, "Jungle" type
 Access width: 0.85 m (centre – centre)
 Height of sides: 1.20 m
 Mesh size: approx. 300 x 300 mm

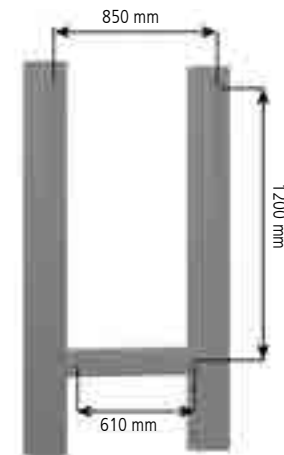

Handrail height: 120 cm, "Footbridge" type
 Access width: 0.85 m (centre – centre)
 Height of sides: 1.20 m
 Mesh size: approx. 300 x 250 mm

Beam length: In front of* posts



We need the following information with your order:

- Soil and environmental composition
- Dimensions (see sketch on Page 258)
- If you already have a frame, we need an exact description of its construction:
 - What shape is the frame? (rectangular, V-shaped or other)
 - What size is the frame? (width, height, beam girth)
 - Where is the crossbeam? (behind, in front of or between the vertical beams)
- Prefer the bridge to be secured with: nuts for eyebolts, recessed or not
- Mesh size of the handrail (this determines the gap between drill holes)
- Length between the vertical beams (handrail length)
- Length between cross beams (footbridge or tightrope length)

* as seen from the bridge.



Tailor-made net bridges

We deliver the individual bridges in the appropriate lengths with access components, foundation or reinforcement designs and assembly instructions. We can include assembly if you so wish. The length of the bridge is based on the gap you want it to span, plus the required distance from the water's edge to the access point (approx. 1.50 m). Please send us a sketch including the key measurements, as shown below. To help you best plan our custom-made net bridges, we have summarised the key project planning tasks. Please follow this when you order.

Individual connection and construction parts are either decided by us according to the bridge type or are adapted to existing suspension builds following in-depth discussions with you.

We fit the net bridges with a variety of underfoot materials and connection components.

When you order, please refer to the measurements given in the sketch where possible (a, b, c, d, d², e, f). With the help of this information we build a bridge that conforms to EN 1176 (playground area; max. feet height 3.00 m with appropriate fall protection) or DIN 1055/1072 for public constructions.

Details for your order/inquiry:

- a) clear measurement between the frame or the tower builds (if it exists already)
- b) measurement between any existing embankment edges
- c) measurement between the embankment edge and any existing frames
- d) measurement from the top edge of the play level to any existing water surface
- d²) measurement from the top of the play level to the lowest point on the ground
- e) preferred or existing access height
- f) soil category number (if known)

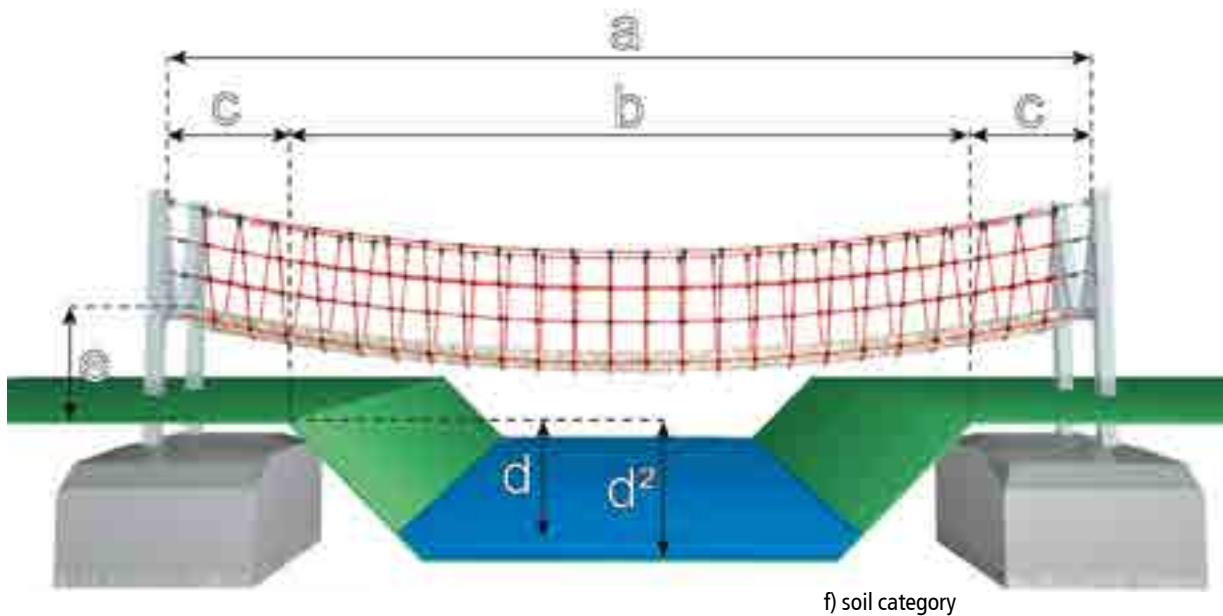

Soil categories

In the construction industry, soil is divided into a total of seven soil and rock categories according to its removability and soil engineering properties. These form the basis for selecting suitable soil, rock and soil construction methods and the calculation of construction costs. The soil category is determined by geotechnics or engineering technology experts.

- Soil category 1: surface soil (topsoil)
- Soil category 2: flowing soil types
- Soil category 3: easy to remove soils
- Soil category 4: medium difficulty to remove soils
- Soil category 5: hard to remove soils
- Soil category 6: Rock categories
- Soil category 7: Hard to remove rock

Net Bridges & Net Tunnels

– as individual as it gets

Whenever even the large variety of our HUCK catalogue is just not enough, we can realise individual solutions – tailor-made for your project and its specific requirements. We offer a made-to-order service! The following pages give examples of individual customer solutions which we developed, produced and constructed. Using our expertise and many years of experience in developing rope play equipment, we create the perfect experience for your indoor or outdoor projects. Because we know what matters.



“Sport-Paradies” (Sports Paradise) in Gelsenkirchen, Germany: 21 m long jungle bridge, enclosed as a net tunnel, with 1.25 m slack
(www.sport-paradies.de)



Individual running surfaces

We plan and produce individual bridge systems tailored to our customers' requirements from ropes, rope components and wooden rungs in various colours designed for playgrounds (EN 1176) and public areas.

- ⊕ Ropes, rope sections and wooden rungs can be replaced on a single basis
- ⊕ Available in 6 different colours of rope and 4 different rung materials
- ⊕ Minimum 5-year guarantee on all parts (except wear and tear and vandalism)
- ⊕ Full maintenance possible according to the required intervals and respective to the applicable norms
- ⊕ Complete solutions with planning, completion and assembly, including documented statics/testing statics and construction supervision, available on request

HUCK uses high quality materials to make its runners. The rung surface can be ribbed to minimise the risk of slipping on request.



HUCK plans and produces individual rope tunnels and steps in various lengths and designs on request!

Available underfoot materials for wooden footbridges



Large hanging bridge in Saarbrücken Zoo.

HUCK uses high quality materials to make its runners. The rung surface is ribbed for safety reasons, to minimise the risk of slipping.

Rungs made from Douglas fir timber

Properties: Split-heart, branch-free quality, dried, planed, rounded along length and ends, pressure-proofed and varnished, option of cracked-look
Recommended use: playgrounds, public areas

Rungs made from oak

Properties: splinter-free, dried, planed all over, rounded along lengths and ends, varnished
Recommended use: playgrounds, public areas

Rungs made from massaranduba hardwood (alternative to bankirai wood)

Properties: hardwood (resistance category 1), high density, extremely weather resistant, rounded along lengths and ends
Recommended use: Swimming pools, wetlands, playgrounds, public areas

Rungs made from synthetic materials

Properties: environmentally friendly, rot-proof, water resistant, high colour and UV-ray resistance, absolutely splinter-free, easy cleaning.
Recommended use: swimming pools, wetlands



Educational forest trail in the treetops

It's becoming fashionable again to holiday in Germany, making recreational parks the place to be. Even ski resorts in the Central German Uplands are having to look to alternatives to attract tourists, now there's less snow and a shorter winter season. HUCK has just the solu-

tion they need – educational forest trails, suspended high up between the trees, taking you through the forest, over zoos and vista points. Giving visitors a very special insight into the surrounding countryside, flora and fauna.



"Biosphere House" in Fischbach, Germany

Jungle bridge enclosed to become a tunnel, length 7.00 m, weight approx. 450 kg
 Wooden footbridge enclosed to become a tunnel,
 Applicable width 1.00 m, length 8.70 m, weight approx. 720 kg
 Net tunnel with swinging discs, length 10.90, weight approx. 795 kg
 Joint project with Sport-Gerlach
www.biosphaerenhaus.de

**Winterberg, Germany**

Jungle bridge enclosed to become a tunnel,
length 15.00, weight approx.950 kg
Wooden footbridge enclosed
to become a tunnel,
applicable width 1.00 m, length 15.00 m,
weight approx. 1300 kg
Net tunnel with swinging discs,
length 15.00, weight approx.1150 kg
Joint project with Sport-Gerlach
www.panorama-bruecke.de

National Park Hainich, Germany

Jungle bridge enclosed to become a tunnel,
length 20.00, weight approx.1170 kg
Wooden footbridge enclosed
to become a tunnel,
applicable width 1.00 m, length 20.00 m,
weight approx. 1760 kg
Swaying vista (net with a 130 x 130 mm MS
as underfoot material)
at approx. 23.00 m level
Joint project with Vollack
www.nationalpark-hainich.de





HUCK N.V.
T.V.B. SA.
Obra Design

Chlorophylle, Dochamps, Belgium
Jungle, wooden footbridge and running net bridges, handrail height 1.20 m
Total length approx. 60.00 m

HUCK Nets UK Ltd.
The Play Practice (Scotland) Ltd.

Romano Park, Stockton-on-Tees,
Great Britain
Jungle bridge
Handrail height 1.20 m
Lengths 2.50 / 2.25 / 2.50 m



**HUCK N.V.**

Theme park Plopsaland NV, Belgium

V-shaped wooden footbridge

Handrail height 1.20 m

Length: 2 x approx. 23.00 m

**HUCK Seiltechnik GmbH
Sauerland Spielgeräte (play equipment)**

City of Bottrop

Jungle bridge

Handrail height 1.20 m

Length 16.00 m



**HUCK Seiltechnik GmbH
Karcher Ingenieurbüro
(engineering company)**

Steinwasenpark, Oberried, Germany
Jungle and wooden footbridge
Handrail height 1.20 m
Length: 2 x approx. 21.00 m



**HUCK Seiltechnik GmbH
ScanCord AB**

Stadtpark Västra Hamnen,
Malmö, Sweden
Net tunnel with wooden footbridge
Handrail height 2.00 m
Length 40.00 m

**HUCK Seiltechnik GmbH
A&P Projects**

LGA Neu-Ulm (Glacis-Ost)
Play system designed like a cocoon
incl. connecting bridges,
net climbers and slides



Saarbrücken Zoo

Wooden footbridge
 Handrail height 1.20 m
 Length approx. 42.00 m



HUCK Seiltechnik GmbH
Huck Occitania S.A.

La Roche sur Foron (France)
 Net tunnel, diameter 1.00m
 Total length 9.00m.





HUCK Seiltechnik GmbH
BALANCE Erlebnis Lernen, Hildesheim

Indoor climbing wood, Leuna
Net chimney, 1.10 m diameter
Length 4.20/5.70m
V-shaped bridge with safety net,
length 18.00m.



HUCK Torimex

Vergarde recreational park, Zeeland
3-part Jungle Bridge
(2.40m/7.70m/2.50m)
Bright rope colours with rope-end walkway

**HUCK Torimex**

North Holland
2-part bridge (25.70m/11.30m)
Wooden walkway
With bridge interim wooden columns

**HUCK Seiltechnik
Urban Division, Lissabon**

Jungle Bridge, Amadora
21.00m in length, red jungle bridge
with rope-end walkway





Individual playground systems

HUCK's world of rope has an optimal solution for all environmental conditions. No matter if as a safety or climbing net around climbing pyramids, assembly on a hillside or as an interesting

addition to existing playgrounds – HUCK has the experience and know-how to create your own individual play solution.



HUCK N.V.
SD Technics + SD Consulting
Exponent Challenge Technology

Gaia Park, Kerkrade, Netherlands
Flat nets + pyramids with various mesh sizes
Total size approx. 1300 m²



HUCK Seiltechnik GmbH
Karin Belch, Herzogenaurach

Puschendorf play school
 Playground similar to "Fortuna" play course
 (see 45), installed on a hillside.



HUCK Seiltechnik GmbH
Klatrejungel No,
Rune Berge, Førde (Norwegen)

Rope climbing system
 "Haukas School", Norway
 Net combination made from
 various rope and net components
 with rope net tower 1
 (see 118) as main component





HUCK Seiltechnik GmbH
Klatrjungle No., Rune Berge, Førde

“Festplassen” Rope climbing facility, Norway
Net combination made from different rope
and net elements with rope net tower
(page 130) as the main feature



HUCK Seiltechnik GmbH

Climbing garden “4 season’s park”,
Oelde/West Phalia
Between 6 robinia posts is a combination of
different rope elements, creating a climbing
garden for the whole family.





HUCK Seiltechnik GmbH
Turkuaz Park, Istanbul

Adventure playground, Sultangazi (Turkey)
Between two approx. 6.00m high towers spans a net bridge with wooden walkway. For climbing up and down there is also a climbing chimney, two stainless steel slides or spiral staircase.



HUCK Seiltechnik GmbH
HUCK Occitania, Maurens-Scopont

"Gurson" play area, France
DINO XXL rope net pyramid (Page 133) as the main feature enhanced by different climbing nets and net bridges to naturally grown robinia posts





**HUCK Seiltechnik GmbH
SIA Jurmalaz Mezaparki**

"Pencil Park" Jurmala, Latvia
Between high, colourful pine wood
"posts" play and climbing areas
become one large adventure course..



HUCK Seiltechnik GmbH

Georg-Rollhagen Primary school, Berlin
A combination of two birds nest trees
(page 71), linked by one rope bridge.

**HUCK Seiltechnik GmbH
Handelsvertretung Götze**

Combination of one birds nest tree
(Page 71) with galvanised crossbars
and additional climbing nets and net
footbridges to a stainless steel slide



Technical specifications

– Everything you need to know



TÜV-tested HUCK quality

EN 1176 and EN 1177 set out safety standards across Europe. These norms regulate the technical requirements for a piece of play equipment and its safety testing. It also covers inspection and maintenance.

Our products conform with the safety requirements set out in EN 1176 and EN 1177 and are all TÜV-tested and certified. HUCK rope play equipment therefore also complies with the requirements of the GS mark "Geprüfte Sicherheit" (tested safety). In the catalogue, however, it is only market with the TÜV seal. We can provide you with detailed information on this subject on request. When the test standards or our play equipment change, we arrange for a retest – that's a promise.

According to EN 1176 and EN 1177, all play equipment must have an impact-minimising safety underlay depending on the fall height, and this underlay has to meet certain criteria. The exact properties and strength of the material are set out in the EN and are presented in the table below.

Please note the A-variance according to Table D.1 in DIN EN 1177, which is an additional stipulation for Germany. This declares that, in Germany, grass provides sufficient protection as safety underlay with fall heights of up to 1.50 m.

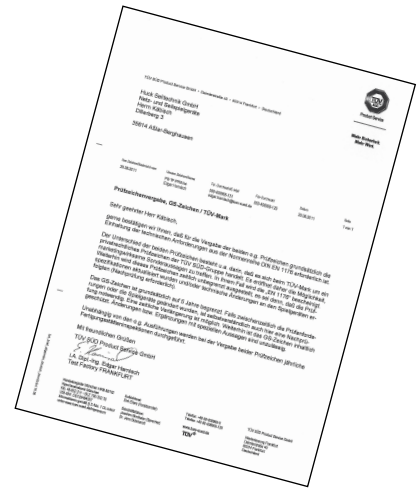

Safety surfaces and fall heights

EN 1176-1: 2008

Sequential number	Ground material	Description	Minimum layer thickness in mm	Max. height of fall in mm
1	Grass	European composition		≤ 1000
2	Grass	Specific regulations for Germany		≤ 1500
3	Wood chippings	Mechanically reduced wood (no wood materials), free from bark and foliage, chip size 5 mm to 30 mm	300	≤ 2000
			400	≤ 3000
4	Bark mulch	Bark chippings from coniferous wood, chip size 20 mm to 80 mm	300	≤ 2000
			400	≤ 3000
5	Sand	No silt or clay deposits, washed, chip size 0.2 mm to 8 mm	300	≤ 2000
			400	≤ 3000
6	Gravel	Rounded and washed, chip size 2-8 mm	300	≤ 2000
			400	≤ 3000
7	Synthetic fall protection	With relevant HIC-testin		≤ 3000

Regional variances apply.



The Hercules quality



Abrasion-proof Hercules rope

The HUCK expertise comes into its own when it comes to ropes: Hercules rope consists of six twisted, 2.5 mm thick, steel strands, which are each composed of 7 individual, galvanised threads. The result is a rope that is extremely resistant and exceptionally robust.

Polyester yarn covering

Every strand is coated in a 6 mm-thick high quality polyester yarn. Unlike other synthetic materials, polyester is exceptionally abrasion-proof and has a very high colour and UV durability.

Secure attachment

Specially-made fittings create a secure attachment between the steel core and the fabric polyester jacket.

Special anti-abrasion proofing

Rope play equipment can easily get worn down. The HUCK Hercules rope has added protection from wear with a specially-made, clear outer proofing.

Abrasion testing

Regular abrasion tests on a specially-developed testing machine show no reduction in quality and attest its superiority over other types of rope. In the abrasion tests, a frictional object is rubbed back and forth over the rope's sur-

face ("double stroke"), until it reaches the steel core. The number of double strokes completed reflects the increased protection of our ropes in the face of repeated use.

Ties

Our ties (e.g. the tried and tested HUCK knot system) are made from high quality synthetic materials. They are extremely durable and particularly comfortable to play on, which sets them apart from the rest. They are formed without any sharp edges or corners.

Easy onsite replacement

The forward-thinking design of our components means replacing individual parts onsite is just as easy as replacing individual rope sections.

Colour-coordinated

For bright-coloured nets, we would normally use bright-coloured ties. In the case of natural rope colours (grass), we install coordinating beige ties.



The HUCK post solutions

HUCK always focuses on safety and durability with all of its play equipment. With different types of posts made from steel and wood, planners and operators can match their play equipment completely with their needs and desires – durability included.



Steel

The HUCK steel posts consist of galvanised steel for high stability and corrosion resistance. Using a high-quality, special paint (included in the delivery), the posts can easily be painted on site. Alternatively, in certain designs HUCK also offers a high quality powder coating in all common RAL tones. HUCK ensures a 15-year warranty on steel posts.



Robinia

Robinia posts give HUCK play equipment a special natural look. This wood, the only one in Europe with resistance class 1, is approved for insertion into the ground without requiring chemical treatment. HUCK provides a 5-year warranty on robinia woods and the guaranteed splinter-free posts are an additional quality criterion. These woods are also fitted with a safety steel plate.



Oak

Posts made of oak are both durable and affordable. HUCK offers these pressure treated or varnished. The oak posts are equipped with additional safety plates. HUCK guarantees a 3-year warranty.



Douglas fir

The Douglas fir is the standard wood for most HUCK equipment. This free-of-heart and split-resistant wood is pressure treated and is only available with galvanised post shoes. This ensures that the wood does not come into direct contact with the soil. HUCK offers a 10-year guarantee for the wood and a 15-year guarantee for the post shoes.

Additional safety for wooden posts

The durability of wood is at stake if it is permanently installed in moist soil. For this reason, HUCK recommends using post shoes (left), in which the wooden posts are totally protected and secure and they have no direct contact with the surrounding soil.

Steel plates (right) are a cheap alternative. They are bolted onto the sides of the wooden posts. They stabilise the wooden posts in the long run and prevent bending if damage occurs.

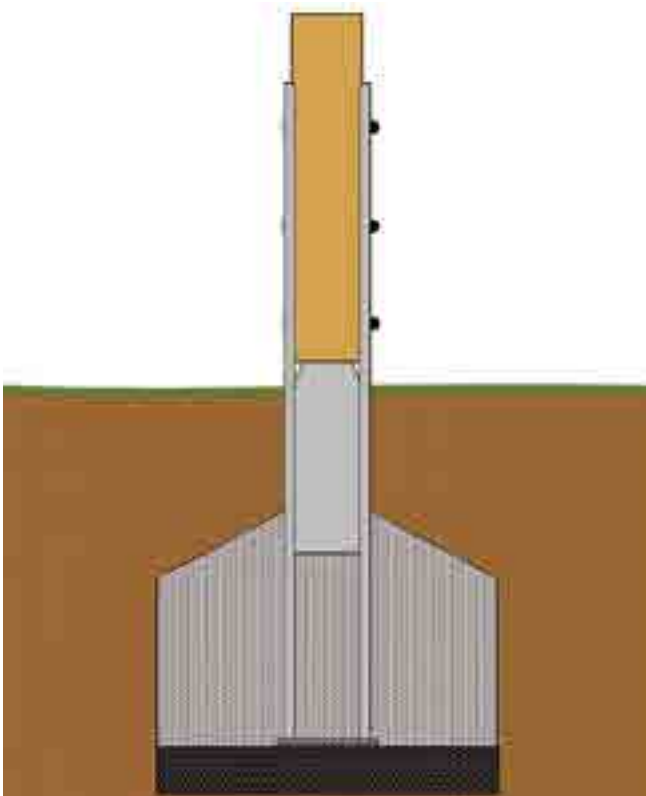

Post shoes protect the wooden posts from direct contact with the surrounding soil.

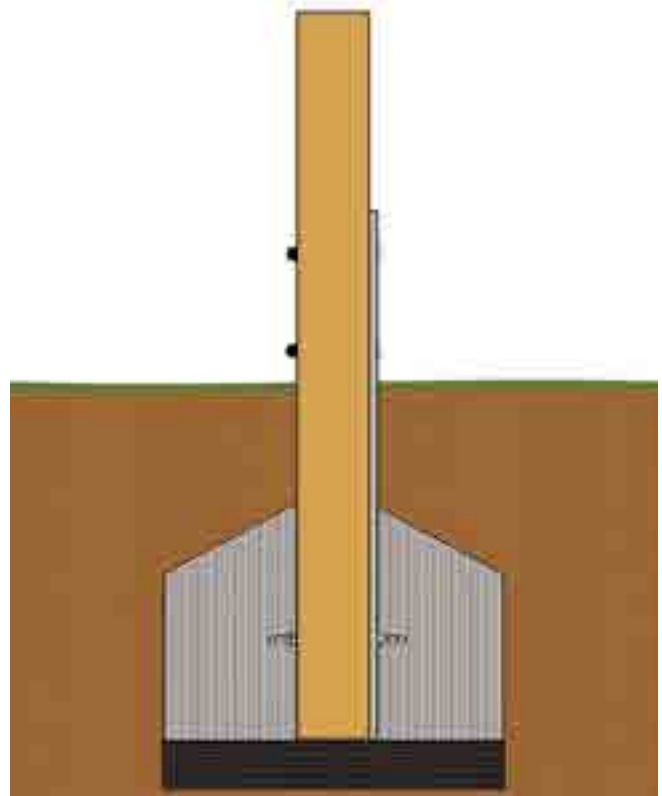

Steel plates stabilise the wooden posts in the long run and prevent bending if damage occurs.



Slides

Every playground should have slides of various lengths and designs. All HUCK slides are made from GRP, a robust and hard-wearing glass fibre reinforced plastic, providing guaranteed maintenance-free fun for years.

Up to a 1.00 m pedestal, all slides come in green as a standard colour. From a pedestal height of 1.50 m, all slides come in yellow as a standard colour. Other colours are available on request.

The different slides are also available in stainless steel for an additional charge.

As with all HUCK play equipment, our slides can also be combined with other components. We are happy to make an offer just for you!





Member of BSFH (Federal Association for manufacturers of playground equipment and recreational facilities e.v)

HUCK is founding member of the BSFH. As a German business association for manufacturers of playground equipment, fall protection flooring and equipment for park and leisure facilities the BSFH keeps its members informed and promotes shared commercial and techni-

cal development. Furthermore it supports the professional interests of the sector as well as the commercial and technical interests of its members in the face of official, commercial and other institutions at home and abroad.

Index

A			
Accessories for robinia posts	241	Climbing net connections	235
Accessories range	246	Climbing net fastening options	236
Adventure bridge	26	Climbing nets	231
Adventure bridge "climbing wall"	47	Climbing pyramids	108
Adventure bridge "crawl tunnel"	27	Climbing rope(s)	244
Adventure bridge "wobble disc"	26	Climbing star	41
Adventure bridge "wobble rung"	45	Climbing whirl	160
Adventure bridge "wooden catwalk"	46	Clips-nets	215
Adventure course	101	Close range play facilities	216
Adventure-honeycomb nest	32	Concrete-in aerial runway	203
Anti-vandalism nets	215	Contact HUCK rope technology	6
"Arch bridge" birds nest tower combi	44	Course	85
Arch swing	168	Course for team building	102
Articulated swing hook	189	Course with robinia posts	86
Articulated swing hook, reinforced	190	Craw tunnel	27
"Asslar" eagles nest®	107	Customised bridges	258
"Attighof" hourglass	83		
		D	
B		Dig-in aerial runway	203
Baby cradle	185	"Dillenburg" adventure course	100
Baby seat	185	"Dillenburg" adventure course	
Basketball net	226	individual elements	101
Beehive carousel	155	Dino 1 rope net pyramid	135
Play ship	69	Dino 2 rope net pyramid	136
Birds nest	12	Dino 3 rope net pyramid	137
Birds nest base repair set	177	Dino rope net pyramids	132
Birds nest carousel	162	Dino XXL rope net pyramid	133
Birds nest springer	30	Dish swing	184
Birds nest suspension bearing	190	Douglas fir swing frame	221
Birds nest tower	77	Douglas fir swing frame, long	167
Birds nest tree	71	Douglas fir swing frame, short	166
Birds nest wrapping rope repair set	177	Dralo® ball safety fence	217
Black forest" birds nest tower	79	Dralo® ball safety wire fence	217
Bollard	248	Dralo® football area goal net	221
Bollard rope	248	Rotating swivel	188
Bollards	248		
Bridge frames	257	E	
Bridges	251	Eagles nest carousel	29
Bridges + Tunnel project	264	Eagles nest tree	75
BSFH information	280	Eagles nest" springer	29
"Eagles Lair" eagles nest	105	Eagles nest® range	103
Buried frame for trampoline	147	Easy swing "honeycomb nest"	174
Buried ground anchor information	249	Easy swing "swing bed"	173
Buried trampoline frame	147	"Ehringshausen" Eagles nest	106
		Ellipsisilon	156
C		End fasteners for climbing nets	236
Canopy walkway	262	Erda" climbing jungle	55
Carousel	31		
Chain fittings for swing seat	183	F	
Chain-link roll mats for slope reinforcement	247	Fall height and subsurfaces	275
Cheops pyramids	118	Flat roof assembly	250
Chimney	256	"Fortuna" birds nest tower	18
"Circus" trampoline	144	"Fortuna" course	43
Clambering loops	243	Frames for bridges	257
Clambering rings	243	Fun course 2010	92
Climbing chimney	178	Fun-course individual elements	93
Climbing chimney per running metre	256		
Climbing circus	154	G	
Climbing fun-individual elements	93	Garland clamber rope	242
Climbing net attachments	235	Gnome tree	20
		"Goalie" football area goal	223

"Goalie sport" football area goal	224	"Lotteschule" Eagles nest	104	Net pyramid	108
Ground anchor chain for climbing rope	244			Net tower "The Lookout"	58
Group swing	192	M		Net tunnel	251
Gymnast rings	242	M swing	24	Net tunnel per running metre	255
H		Mahulan steel – ball safety net	219	Nets	233
"Haiger" individual elements	89	Mahulan Steel goal net	219	News	9
"Haiger" rope course	88	Mahulan Steel net	215	O	
Hally-Gally series	140	"Mahulan Steel" football area goal net	220	Obstacle-free rope play equipment	204
Hally-Gally Trampoline	141	Maxi Cheops combination	121	Original Hally Gally series	140
Hammock made from Hercules rope	201	Maxi Cheops pyramid	119	Original HUCK birds nest	12
Hammock with plastic knot clips	201	Maxi climbing castle	56	Original HUCK birds nest springer	30
Hammock(s)	200	Maxi climbing wigwam	82	Original HUCK honeycomb nest	176
Hercules climbing rope	244	Maxi super rope end swinger	195	Original HUCK mini birds nest	176
Hercules rope	234	Maxi swing for those of limited mobility	186	Oval rope ring swing	179
Hercules rope climbing nets	233	"Maxi" Easy swing	172	P	
Chain-link roll mats for slope reinforcement	247	Midi "Bellersdorf" play ship	67	Partner swinger	25
Lifting device for trampoline	147	Midi birds nest tree	73	PE buttons for sand pit cover sheets	230
Hercules climbing rope	244	Midi Cheops combination	125	Pendulum seat combination	151
Hercules rope	234	Midi Cheops pyramid	123	Pendulum seats	184
"Hercules rope" football area goal net	222	Midi climbing whirl	161	"Piccolo" trampoline	147
Hercules rope climbing nets	233	Midi climbing wigwam	57	Pirate castle	54
Hercules rope hammock	201	Midi super rope end swinger	196	Plastic clips	235
Hercules rope-ladder	245	Midi swing for those of limited mobility	186	Plastic knot clips hammock	201
"Hercules rope" football area goal net	222	"Midi" Easy swing	172	Play landscape projects	270
Honeycomb nest	176	Midi climbing whirl	161	Play ship	69
HUCK Birds nest	12	Mini birds nest	176	Polyester hammock	201
HUCK Birds nest springer	30	Mini birds nest carousel	162	Polypropylene climbing nets	233
HUCK Honeycomb nest	176	Mini birds nest tree	17	Polypropylene climbing ropes	244
HUCK International	6	Mini Cheops pyramid	127	Polypropylene rope for wooden bollard	248
HUCK Mini birds nest	176	Mini climbing castle	40	Polypropylene rope-ladder	245
HUCK rope technology contact partner	6	Mini climbing pyramid	158	Polypropylene running surface rope	252
I		Mini hexagon climbing castle	40	Post caps	249
Illustrations	8	Mini hourglass, spinning	59	Post layout	277
Individual elements	101	Mini M swing	24	Posts	277
Information	275	Mini M swing suspension bearing	191	PP climbing nets	233
International branches + partners	6	Mini pirate tower	42	PP climbing rope	244
J		Mini rope-end swing	33	PP climbing nets	233
Jungle bridge incl. frame kit	252	Mini super rope end swinger	197	PP rope for wooden bollards	248
Jungle bridge per running metre	252	Mini super rope end swinger		PP rope-ladder	245
Jungle rope swing	179	4-seater, double	199	PP running surface rope	252
"Junior" play ship	21	Mini super rope end swinger	198	Pyramids	108
"Junior" swing frame	169	4-seater, single	198	Q	
K		Mini swing for those of limited mobility	186	R	
Toddler swing	185	Mini tower carousel	159	"Rabenscheid" super rope end swinger	193
Knot balls	235	Mini trampoline	147	"Rabenscheid" tent net	52
Knot connections	234	Mini triops® combination	129	Recreational equipment	214
Knot tied	235	Mini triops® pyramid	128	Robinia posts	86
L		Mino "Fortuna" pirate tower	15	"Rolli" trampoline for wheelchair users	148
Lantern climbing nest	64	N		Roman rings	242
Lantern swing nest	64	Nature trail	262	Rope course	85
Large climbing pyramid	157	Nest carousel	31	Rope end swinger	181
Launch pad" play facility/centre	66	Nest swing	12	Rope net pyramids	108
Lawn protection grid mat	247	Nest tower	77	Rope net tower 1	130
Lawn protection mat for swings	247	Nest tree	71	Rope net tower 2	131
Liana swing	152	Net bridge, single	254	Rope play course	85
Lifting device for trampoline	147	Net bridges	251	Rope play equipment	14
List of keywords	281	Net chimney	256	Rope play equipment for children	
		Net for basketball	226	aged 3 and above	28
		Net for volleyball	225	Rope play equipment for children	
		Net handrail for bridges	253		
		Net handrails for walkways	253		

aged 4 and above	51	"Black Beard" pirate tower	80	Witches coven version 2	37
Rope play equipment for children		Sub surface and fall height	275	Witches coven version 3	37
aged 6 and above	65	Sun pavilion cover combination	229	Witches hiding place	38
Rope play equipment, obstacle-free	204	Sun sail	227 - 229	Witches lookout	23
Rope quality	276	Sun sail projects	228	Witches slide and net	22
Rope ring swing	179	Super-climb Maxi	138	Wobble disc	26
Rope ring swing carousel	178	Super-climb Midi	139	Wooden net seesaw	60
Rope swing	179	Super-climb Mini	139	Wooden walkway	37
Rope-ladders	245	Super rope-end swingers	193		
Rubber edging cord for sandpit covers	230	Support posts for hammock	200	X	
Rubber floor steps	253	Suspension bearing	189	XXL hammock	202
Rubber hammock	200	Suspension bearing for Mini M swing	191		
Running rope	252	Swing bed	187	Y	
Running surface rope	252	Swing frames	165		
Rustic board swing	183	Swing hook	189	Z	
Rustic" partner swing	180	Swing nest	12		
		Swing seat, black	183		
S		Swinging honeycomb nest	32		
Safety bearing	191	Swings	165		
Safety suspension bearing	189				
Safety swing seat	183	T			
Sandpit cover sheet	230	T&Cs	285		
Sandpit covers	230	Table of contents	3		
"Saturnus" Trampoline	145	Team-building course	102		
Seesaw	60	Technical information	275		
Shackle rotating swivel	188	Tightrope	63		
Single net bridges	254	Toddler-partner swing 2-seater	182		
Single tyre swings	184	Toddler-partner swing 4-seater	182		
Sky-castle	53	Toddler-partner swinger	25		
Slack line	62	Tower carousel	158		
Slackmaster	48	Trampoline	141		
Slackmaster combination 1	49	Trampoline 2000	143		
Slackmaster combination 2	50	Trampoline 2012	149		
Slides	279	Trampoline 2014	150		
slope reinforcement	247	Trampoline lifting device	147		
Space capsule	153	"Triangulum" trampoline	146		
Sparrows nest with slide	19	Trio swing	180		
SPIDER 4 rope pyramid with 4 guy ropes	111	Tunnel	255		
SPIDER 4 with 4 guy ropes	111	TÜV (German technical control board)			
SPIDER 6 rope pyramid with 4 guy ropes	113	information	275		
SPIDER 6 rope pyramid with 6 guy ropes	115	Tyre swing with net base	184		
SPIDER 6 with 4 guy ropes	113	Tyre swing, single	184		
SPIDER 6 with 6 guy ropes	115				
SPIDER 8 rope pyramid with 6 guy ropes	117	U			
SPIDER 8 with 6 guy ropes	117	Underground garage assembly	250		
SPIDER pyramids	110	Universal joint for Birds nest swing	190		
Spider web pyramid	110	Universal joint with rotating swivel	188		
Spinning mushroom	84				
Spinning toadstool	164	V			
Spiral carousel	163	V-form bridge	254		
Sports day assault course	87	V-form net bridge	254		
Sports equipment	214	Vario individual elements	97		
Spring device	30	Vario system	96		
Stainless steel clips	235	Vario-system individual elements	97		
Stainless steel slip-on sleeves	235	Volleyball net	225		
Static hammock	202	Volleyball net set	225		
Steel net seesaw	61				
Steel posts for polyester hammock	201	W			
Steel rope link hammock	200	Walkway	253		
Steel tube swing frame long	170	Witches carousel	164		
Spider web net	39	Witches coven	22		
"Black Beard" pirate ship	81	Witches coven version 1	36		

